

**The Great Grid Upgrade**

Sea Link

# Sea Link

**Volume 9: Examination Submissions**

Document 9.17.1: Suffolk Drainage Strategy

Planning Inspectorate Reference: EN020026

Version: B  
March 2026

**nationalgrid**

**Page intentionally blank**

# Contents

<b>1.</b>	<b>Introduction</b>	<b>1</b>
1.1	Introduction	1
1.2	Project Overview and Scope	1
1.3	Drainage Stakeholders Consultation	3
<b>2.</b>	<b>Suffolk Sea Link Route</b>	<b>5</b>
2.1	Site Description	5
2.2	Cable Route	5
2.3	Data Sources	5
2.4	Standards and Guidance	7
<b>3.</b>	<b>Existing Topography</b>	<b>10</b>
<b>4.</b>	<b>Existing Hydrology</b>	<b>12</b>
4.2	Watercourses	12
4.3	Lakes and Reservoirs	14
4.4	Existing Drainage	14
4.5	Existing Field Drainage	14
4.6	Flood Zones	15
4.7	Friston Substation Site	16
<b>5.</b>	<b>Existing Ground Conditions</b>	<b>18</b>
5.2	Geology	18
5.3	Contaminated Land	24
5.4	Groundwater and Source Protection Zones (SPZ)	25
<b>6.</b>	<b>Surface Water Drainage Design Strategy</b>	<b>27</b>
6.1	Overview	27
6.2	Design Guidance and Policy	27
6.3	Runoff Destination	30
6.4	Management of Extreme Rainfall and Flooding	31
6.5	Management of Everyday Rainfall (Interception)	42
6.6	Proposed Drainage Features	43
6.7	Field Drainage Management	46
6.8	Groundwater Management Features	48

<b>7.</b>	<b>Foul Water Drainage</b>	<b>51</b>
7.2	Temporary Foul Water	51
7.3	Permanent Foul Water	51
<b>8.</b>	<b>Water Quality</b>	<b>53</b>
8.2	Consents	57
<b>9.</b>	<b>Amenity</b>	<b>59</b>
<b>10.</b>	<b>Biodiversity</b>	<b>60</b>
<b>11.</b>	<b>Design of Drainage for Construction, Operation, Maintenance, decommissioning and Structural Integrity</b>	<b>61</b>
11.2	Maintenance	61
11.3	Decommissioning	62
11.4	Structural Integrity	63
<b>12.</b>	<b>Conclusions</b>	<b>64</b>
12.1	Assumptions and Risks	64
12.2	Opportunities	65
<b>Appendix A Preliminary Drainage Design Summary</b>		<b>A.1</b>
<b>Appendix B Drainage Layouts</b>		<b>B.1</b>
<b>Appendix C Additional Insets</b>		<b>C.1</b>
<b>Appendix D Consultation Responses</b>		<b>D.1</b>
<b>Appendix E Soakaway Tests</b>		<b>E.1</b>
	Plate 1.1 Sea Link proposed marine routing	2
	Plate 3.1 Existing Elevations	10
	Plate 4.1 Typical land drainage layouts	15
	Plate 5.1 Trial pits and boreholes from the GI dated 2024	21
	Plate 5.2 SPR GI locations	24
	Plate 6.1 Climate change uplift allowances for peak rainfall	30
	Plate 6.2 PIMP values for a typical cable construction layout	37
	Plate 6.3 Overall % PIMP calculations for HVDC construction swathe	39
	Plate 6.4 Overall % PIMP calculations for HVAC construction swathe	40
	Plate 6.5 Basin with Forebay detail	44
	Plate 6.6 Proposed swale to intercept flows from the permeable subbase of the platforms	45
	Plate 6.7 Headwall detail with scour protection for permanent works	46
	Plate 6.8 Indicative trench cross section	47
	Plate 6.9 Field drainage diversion layout example	48
	Plate 6.10 Spaced puddle clay stanks along the cable route in the areas prone to groundwater risk	50

Plate 8.1 Outfalls with bank protection for discharge outfall and baffles on discharge hoses for temporary works 55

Table 2.1 Data sources used for assessment	6
Table 2.2 Standards and guidance used for assessment	8
Table 4.1 Cable route watercourse crossings	14
Table 5.1 Permeability test from GI 2024	20
Table 5.2 Permeability test from GI 2022	22
Table 6.1 Infiltration factors of safety	32
Table 6.2 Proposed full infiltration areas	33
Table 6. Independent networks forming drainage strategy	36
Table 6. Overall % PIMP (Percentage of Impervious Area) values for a typical cable construction layout	36
Table 6. Overall % PIMP values for HVDC construction swathe	39
Table 6. Overall % PIMP calculations for HVAC construction swathe	39
Table 6. Overall % PIMP calculations for Friston substation	41
Table 6. Overall % PIMP calculations for Saxmundham convertor station	41
Table 11.1 SuDS maintenance plan	62

## Sea Link Document Control

---

### Version History

---

<b>Date</b>	<b>Version</b>	<b>Status</b>	<b>Description / Changes</b>
November 2025	A	FINAL	First issue submitted at Deadline 3
March 2026	B	FINAL	For Deadline 5 submission - update following stakeholder feedback

---

# 1. Introduction

## 1.1 Introduction

1.1.1 This Drainage Strategy and the preliminary drainage design drawings contained herein have been produced to support the application for Development Consent of the Sea Link Scheme (the Scheme). This strategy provides the outline proposals for drainage required for the construction and operation of the relevant onshore elements of the proposed development in Suffolk.

1.1.2 This strategy is intended to provide additional information to that provided in Appendix C of **Application Document 6.8 Flood Risk Assessment [APP-292]**. The strategy is unchanged from that document; however, this document provides site specific detail and demonstrates compliance with the following:

- National standards for sustainable drainage systems (SuDS) first published in June 2025.
- National Policy Statement for Energy EN-1 published November 2023.

## 1.2 Project Overview and Scope

1.2.1 National Grid Electricity Transmission has developed proposals for Sea Link, a planned high voltage undersea electrical link between Suffolk and Kent. Sea Link will add additional capability to the electricity transmission network, enabling low carbon and green energy from other projects to connect to the network and be transported around the country.

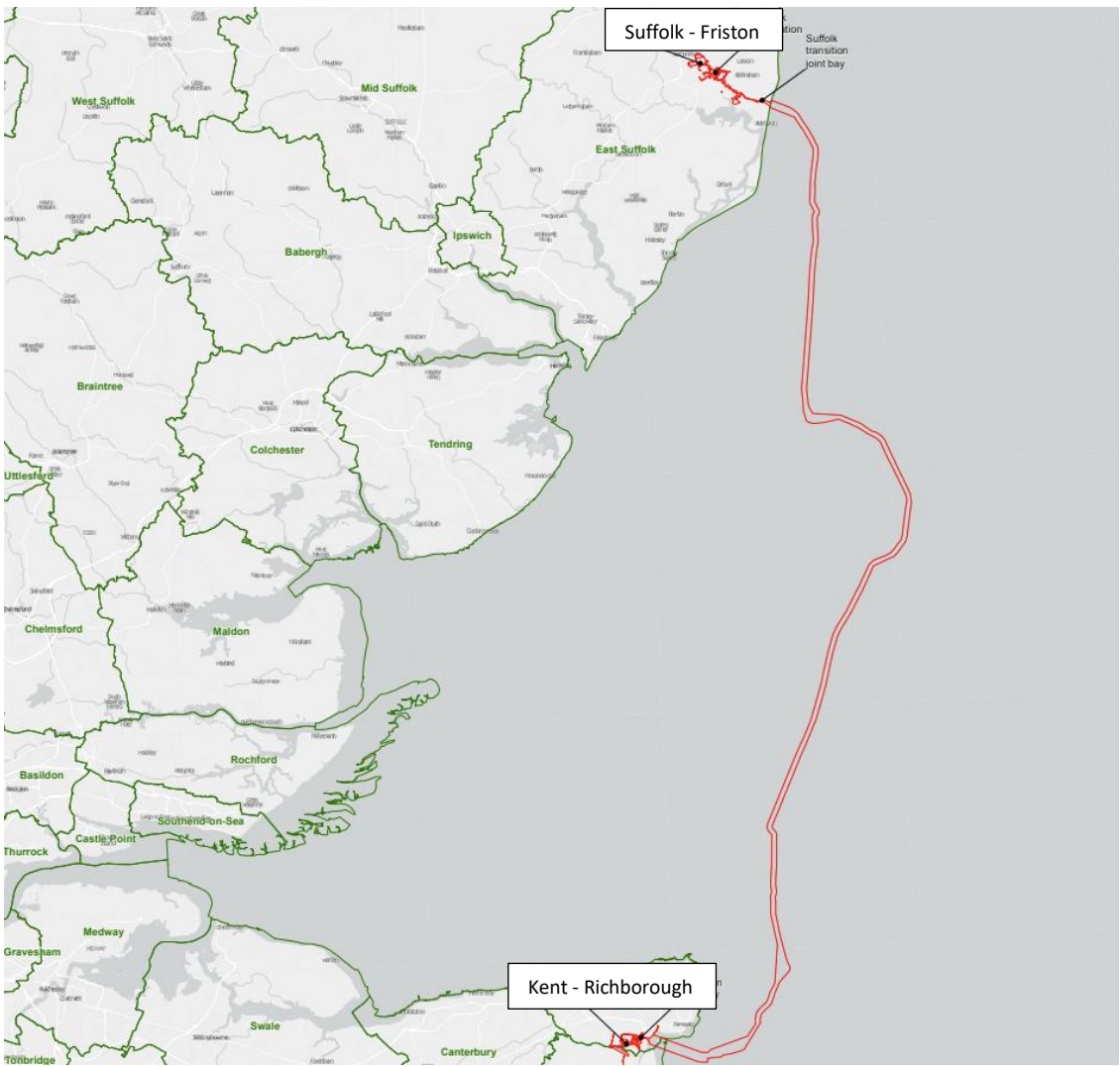

**Plate 1.1 Sea Link proposed marine routing**

Source: 2.2 Location Plans [APP-018]

- 1.2.2 The Sea Link project involves a 2GW HVDC link between Richborough in Kent and Friston in Suffolk which forms part of the solution to resolve the operational boundary issues in the South Coast, East Coast and London Areas.
- 1.2.3 The Scheme includes the installation of onshore HVDC cable alignments in Kent and Suffolk, and the siting of HVDC/HVAC converter stations and HVAC connections to the associated substations. The onshore Kent section and a HVDC underground route from the Kent converter station to the landfall point in Suffolk of circa 120km offshore subsea cables are not covered by this drainage strategy.
- 1.2.4 To enable the Sea Link project to be connected to the wider electricity transmission network, the Suffolk Sea Link project (the focus of this report), comprises the siting of a HVDC and HVAC cable route, a new

converter station at Saxmundham, a new 400kV substation at Friston and the co-location of the new converter stations for the Sea Link project with Nautilus and LionLink projects on the same site.

- 1.2.5 The cable route will be buried for the entire length using a mostly open cut trench with trenchless solutions (e.g., Horizontal Directional Drilling (HDD)) in some locations. Most of the construction swathe comprises undeveloped agricultural land. Details of HVDC and HVAC onshore construction swathes are provided in **2.13 Design and Layout Plans [APP-037]**.
- 1.2.6 For further details describing the Scheme as a whole, refer to **6.2.1.4 Part 1 Introduction Chapter 4 Description of the Proposed Project [APP-045]**.
- 1.2.7 This report has been informed by feedback received during Statutory Consultation alongside consultation meetings with the relevant stakeholder bodies during 2022 and 2023.
- 1.2.8 A stakeholder guidance<sup>1</sup> review is included in Section 6.2.
- 1.2.9 During 2024 a site investigation by Structural Soils Ltd was taken, where soakaways and intrusive boreholes were carried out along the cable route. Additionally, in October 2023 a topographical survey was conducted by 3D Engineering Surveys Limited.

## 1.3 Drainage Stakeholders Consultation

- 1.3.1 Stakeholders have been consulted during the preparation of this drainage strategy, to ensure clear information is communicated regarding general industry practice and the development of solutions to accommodate key constraints. These include the following:
- The Environment Agency (EA) is the principal flood risk management authority in England providing a strategic overview relating to all forms of flood and coastal erosion risk. They are responsible for water quality and resources, and management of risk of flooding from main rivers, reservoirs, estuaries and the sea.
  - Suffolk County Council (SCC) is the Lead Local Flood Authority and is responsible for managing the risk of flooding from surface water, groundwater and ordinary watercourses, and lead on community recovery.
  - East Suffolk Water Management Board (WMB) is the Internal Drainage Board within the East Suffolk drainage district and is responsible for managing water levels both in watercourses and underground (groundwater), by improving and maintaining ordinary watercourses, drainage channels and pumping stations to reduce

---

<sup>1</sup> Suffolk Local Flood Risk Management Strategy - Suffolk County Council

the risk of flooding. Their functions include supervising land drainage and flood defence works on ordinary watercourses within their drainage district boundary.

- North Warren Nature Reserve is in a Site of Specific Scientific Interest and owned by the Royal Society for the Protection of Birds (RSPB), the largest nature conservation charity in England. As custodians of the nature reserve, the RSPB manages the local natural landscape and monitors water quality, vegetation, and key species, with the long-term aim of joining the reserve with a chain of protected sites along the Suffolk coast.

1.3.2 Consultation continues throughout the lifecycle of a project, from its initial stages through to consent and post-consent.

1.3.3 Section 4.2 in this report discusses the regulatory stakeholders for the existing watercourses that interface with the cable route; and Section 8.2 describes all consents required to discharge water into an existing watercourse or work near a watercourse.

1.3.4 A summary of the consultation (feedback and responses received from stakeholders) is provided in Appendix D.

## 2. Suffolk Sea Link Route

### 2.1 Site Description

- 2.1.1 The site is predominantly low-lying, reclaimed agricultural land, with various small settlements in the vicinity of the route corridor. The area is characterised by large fields with few watercourses and ponds. This is an indication of the superficial deposits and bedrock formation geology, as the site is located for the most part in sand sedimentary bedrock geology with Diamicton superficial deposits. The cable route alignment crosses roads, railways, and watercourses.

### 2.2 Cable Route

- 2.2.1 The general arrangement for the FEED Design for Suffolk Sea Link is provided in the DCO application **2.14.1 Indicative General Arrangements Plans – Suffolk [APP-038]**. The proposed cable route is located between OS grid references E646956, N258289 and E639761, N262313. The route runs East to West from Aldeburgh beach to the new Friston substation located at E639761, N262313. This route is approximately 9.1km: 7.4km of HVDC cable route from the landfall transition joint bay to the new 400kV Friston substation and 1.7km HVAC/DC cable route from the new 400kV Friston substation to the new Saxmundham converter station. The corridor shown can accommodate up to three schemes (Sea Link (the focus of this report), LionLink and Nautilus) via the co-location of three new converter stations. The limit of deviation of the project considers the co-location of the three projects.

### 2.3 Data Sources

- 2.3.1 The following data sources have been used for this assessment:

**Table 2.1 Data sources used for assessment**

<b>NAME</b>	<b>FILE REF</b>	<b>SOURCE</b>	<b>DATE</b>	<b>REVISION</b>
Ordnance Survey Mapping	SEAL OS Mapping_OS GB36	Ordnance Survey	2022	N/A
Aerial maps, Openstreet maps	N/A	Google Maps and Earth, Bing	2022	N/A
Magic Map Website: Source Protection Zones	N/A	Environment Agency	2022	N/A
British Geological Survey (BGS) Website: Historic borehole records and geological maps	N/A	BGS website	2022	N/A
Thorpness Hundred River Catchment Map	CMT164G	East Suffolk Drainage Board	2022	N/A
Upper Alde River Catchment Map	CMT175G	East Suffolk Drainage Board	2022	N/A
Suffolk Costal Operational Catchment	Internal Drainage Boards within Suffolk	Suffolk County Council	2022	N/A
Onshore Geotechnical and Geo-Environmental Ground Investigation	SSL Report No: 735329-01 (21)	Structural Soils LTD	2022	N/A
Geotechnical and Geo-environmental Preliminary Risk Assessment (Desk Study) Report - Friston	SEAL-MMD-SEAL-ENG-REG-0056	Mott MacDonald	May 2022	01
OSTerrain 5	N/A	Ordnance Survey	2022	N/A
Memorandum of Understanding Suffolk County Council	SEAL-MMD-SEAL-ENG-REP-0482			

<b>NAME</b>	<b>FILE REF</b>	<b>SOURCE</b>	<b>DATE</b>	<b>REVISION</b>
Memorandum of Understanding East Suffolk IDB	SEAL-MMD-SEAL-ENG-REP-0478			
Memorandum of Understanding North Warren Nature Reserve	SEAL-MMD-SEAL-ENG-REP-0481			
Memorandum of Understanding Environment Agency Suffolk	SEAL-MMD-SEAL-ENG-REP-0477			
Mott MacDonald - Interface with Environment Agency regarding crossing of rivers. Sea Link, Suffolk.	AC/2022/131 336/01-L01	Environment Agency	October 2022	01
Mott MacDonald River Crossing Consultation	KT/2022/130 046/01-L01	Environment Agency	October 2022	N/A
Topographic Survey	DES23051_1	3D Engineering Surveys Ltd	November 2023	
Arboriculture Survey	60664038-ACM-XX-SK-AB-TCP-000	AECOM	March 2024	P01
Suffolk Onshore Cable Link Factual Report on Preliminary Ground Investigation	563835-01 (03)	Structural Soils Ltd	April 2024	03
Summary of Infiltration Testing Technical Note	EA2-ONC-GEO-TEC-IBR-000002	SPR	August 2025	4

## 2.4 Standards and Guidance

2.4.1 The following standards and guidance have been followed in this strategy:

**Table 2.2 Standards and guidance used for assessment**

<b>DOCUMENT NAME</b>	<b>DOCUMENT REFERENCE</b>	<b>PUBLISHER</b>
National standards for sustainable drainage systems (SuDS)		DEFRA
National Policy Statement for Energy EN-1	EN-1	Department for Energy Security & Net Zero
National Grid - Roadworks and Surfacing	TS 2.10.08	National Grid
National Grid - Site Drainage	TS 2.10.09	National Grid
National Grid - Flood Defences for electricity substations	TS 2.10.13	National Grid
The SuDS Manual	C753	Construction Industry Research and Information Association
Culvert design and operations guide	C786	Construction Industry Research and Information Association
Groundwater control - Design and Practice	C515	Construction Industry Research and Information Association
Control of water pollution from linear construction sites	C648	Construction Industry Research and Information Association
Control of water pollution from construction sites	C532	Construction Industry Research and Information Association
National Planning Policy Framework (NPPF) 2021	NPPF	UK Government
Construction Surface Water Management Plan <sup>2</sup>	August 2018	Suffolk County Council
Suffolk Flood Risk Management Strategy <sup>3</sup>	2022	Suffolk County Council

<sup>2</sup> [Construction Surface Water Management Plan - Suffolk County Council](#)

<sup>3</sup> [Suffolk Local Flood Risk Management Strategy - Suffolk County Council](#)

<b>DOCUMENT NAME</b>	<b>DOCUMENT REFERENCE</b>	<b>PUBLISHER</b>
SCC Local SUDS Guidance <sup>4</sup>	March 2023	Suffolk County Council
Department of Environment, Food and Rural Affairs (DEFRA)'s non-statutory technical standards <sup>5</sup>		UK Government
Rural Sustainable Drainage Systems <sup>6</sup>	June 2012 - RSuDS	Environment Agency
Agriculture and Horticulture Development Board <sup>7</sup>	AHDB	Agriculture and Horticulture Development Board

<sup>4</sup> Guidance on development and flood risk - Suffolk County Council

<sup>5</sup> <https://www.gov.uk/government/publications/sustainable-drainage-systems-non-statutory-technical-standards>

<sup>6</sup> <https://www.gov.uk/government/publications/rural-sustainable-drainage-systems>

<sup>7</sup> <https://ahdb.org.uk/>

### 3. Existing Topography

- 3.1.1 The topography of a site can have a significant impact on the constructability of civil infrastructure. OSTerrain 5 data obtained from Ordnance Survey has been used to predict the existing topography of the route. This dataset has an accuracy 2m Root Mean Squared Error (RMSE).
- 3.1.2 A detailed assessment of the topography affected by the cable route and the surrounding areas was carried out by 3D Engineering Surveys in November 2023 and levels from this are included in this drainage strategy report for the identification of drainage outlets into watercourses.

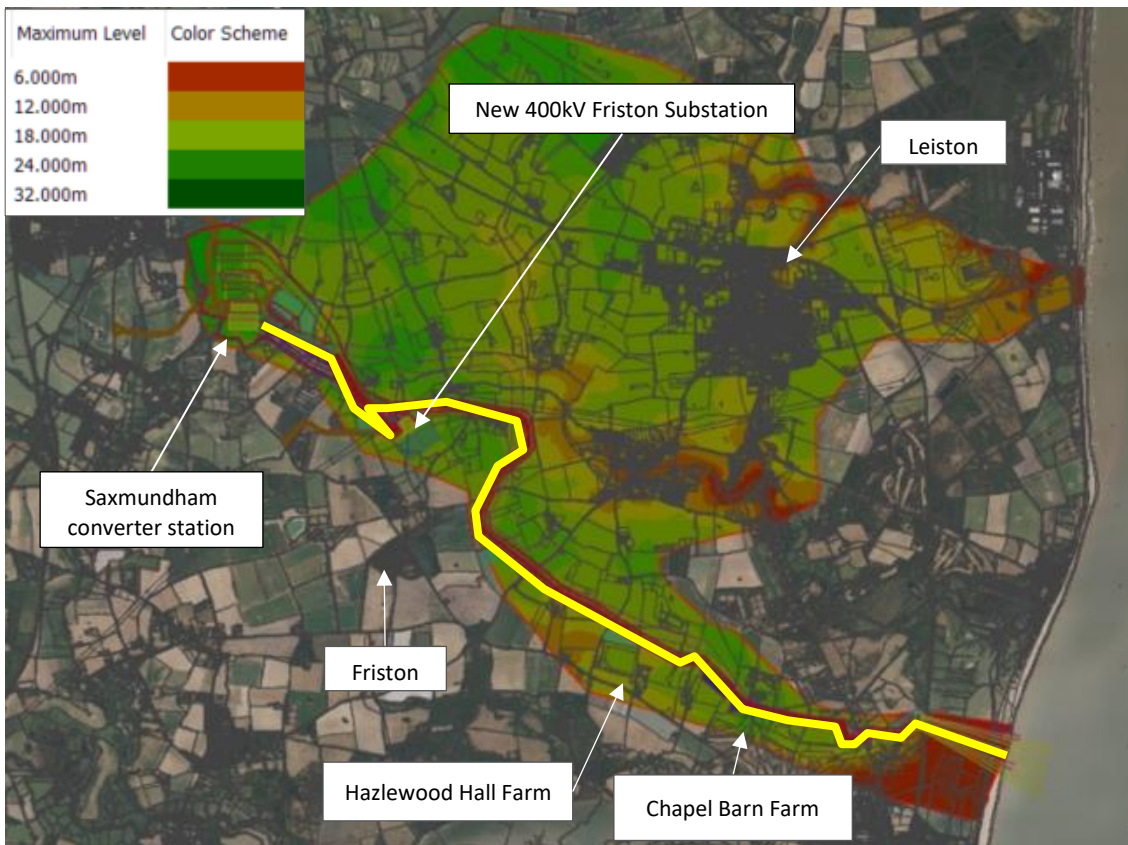

**Plate 3.1 Existing Elevations**

Source: OSTerrain 5 data (2023).

- 3.1.3 The highest elevated section of the Suffolk cable route is +26.00mAOD and sits near the Saxmundham converter station at Ch 9.0km. The new 400kV Friston substation sits at an existing elevation of +16.00mAOD at Ch 7.9km.
- 3.1.4 The cable route is mainly located within two river catchments with ground north of the cable route generally falling to the Hundred River and ground south of the cable route falling generally to the Fromus River (which joins the Alde and Ore River). A study area based on surface hydrological catchments is used to delimitate the boundaries of study area and define the water receptors, upstream and downstream the cable route, see 2.11 Water Bodies in the River Basin Plans [APP-035].

## 4. Existing Hydrology

4.1.1 The cable route alignment sits within two river catchments: Hundred River Basin and Fromus River Basin. The Alde & Ore River catchment is to the south of both proposed cable route, with the low lying Hazlewood Marshes situated immediately north of the River Alde.

### 4.2 Watercourses

4.2.1 Watercourses are classified by the Environment Agency as follows:

- Main Rivers are rivers, larger streams and smaller watercourses of strategic drainage importance regulated by the Environment Agency.
- Ordinary Watercourses are rivers, streams, ditches, drains, sluices and so on which do not form part of a main river. There are two types of Ordinary Watercourses: those regulated by an Internal Drainage Board (IDB), which are usually named; and those that are regulated by the Lead Local Flood Authority (LLFA), which are usually unnamed.

4.2.2 The cable route crosses multiple water features including rivers, watercourses, and ditches. An assessment of the cable route has been undertaken to locate crossings of Main Rivers and Ordinary Watercourses, and to identify the relevant regulatory body for each Ordinary Watercourse. Watercourse crossings are outlined in **6.3.1.4.A ES Appendix 1.4.A Crossings Schedules [APP-089]**.

#### Main Rivers

4.2.3 The only Environment Agency (EA) Main River directly affected by the project is the Fromus River. A permanent access road to the new Saxmundham converter site crosses the Fromus River 800m west. The EA has a national “no culverting” policy therefore the River Fromus is proposed to be crossed by a clear span bridge.

#### Ordinary Watercourses under the Internal Drainage Board (IDB)

4.2.4 There is one Internal Drainage Board district that interfaces with the cable route under the East Suffolk Water Management Board (WMB). Within the district there are two catchments relevant to the development:

- Thorpness Hundred River catchment

- Upper Alde catchment

- 4.2.5 The East Suffolk WMB maps of the catchments (Ref. CMT164G and CMT175G as listed in Data Section 2.3) show the WMB boundary and the watercourses maintained by East Suffolk WMB. However, the East Suffolk IDB district also contains the North Warren Nature Reserve which is crossed by the cable route. It is proposed that the crossing is constructed using Horizontal Directional Drilling (HDD) within the nature reserve. This is secured in mitigation W12 of the **7.5.3.2 CEMP Appendix B Register of Environmental Actions and Commitments (REAC) [APP-342]**.
- 4.2.6 All new surface water discharges into an ordinary watercourse for the Sea Link scheme that lie within an Internal Drainage Board District must be consented by the IDB. The Board follows the National Planning Policy in terms of discharge rate acceptability but considers each proposal on a case-by-case basis. The Board under Section 23 of the Land Drainage Act 1991 issues consents related to the method for crossing an ordinary watercourse within the district.
- 4.2.7 There is a single outfall proposed in an East Suffolk WMB watercourse, a tributary of the River Fromus. This outfall is to serve the permanent drainage networks of the new Saxmundham converter station as shown in the attached Drainage Plans in Appendix B.

## Drainage Ditches

- 4.2.8 For Ordinary Watercourses in Suffolk outside the IDB area, the relevant authority is Suffolk County Council (SCC) as the LLFA. Ordinary Watercourses and ditches affected by the cable route have been identified based on Ordnance Survey mapping data.

## Summary of Watercourse Crossings

- 4.2.9 To identify existing watercourses affected by the cable scheme, OS Mapping, Aerial mapping, Openstreet mapping, and the Magic Map Website were used as data sources. The topographical survey by 3D Engineering Surveys dated November 2023 includes bottom of ditch and top of embankment of many watercourses affected by the scheme, but not all have been surveyed. An indication of the affected watercourses by the new outfall installation with no data are included in Appendix A.
- 4.2.10 A summary of the watercourse crossings identified is presented in Table 4.1

**Table 4.1 Cable route watercourse crossings**

<b>Indicative number of crossings</b>		
<b>Main River</b>	<b>Ordinary watercourse</b>	<b>Ordinary Watercourse</b>
<b>Environment Agency</b>	<b>East Suffolk Water Management Board</b>	<b>Suffolk County Council</b>
1 Crossing of River Fromus by a bridge	4	13

### **4.3 Lakes and Reservoirs**

4.3.1 There are several existing ponds and reservoirs across the cable route. Most of the ponds are within agricultural fields and appear to be outfall locations for land drains.

4.3.2 The HVDC route passes close to three surface water reservoirs at Chapel Barn Farm, where the nearest and furthest reservoirs to the cable route are marked as swimming lakes on OS mapping, and the third is referenced as a basin. The nearest reservoir, called Hazlewood Reservoir, is 50m north of the cable swathe. As per conversations with SCC, this reservoir is used for irrigation of agricultural land. A new construction compound is located to the north of this irrigation reservoir.

### **4.4 Existing Drainage**

4.4.1 Existing Anglian Water foul sewers are in the proximity of the Saxmundham urban area. The proposed permanent access road to the Saxmundham converter station crosses a foul water utility by Anglian Water adjacent to the proposed bridge over the River Fromus. There are no records of surface water or combined sewers in the area adjacent to the Saxmundham converter station or Friston substation.

4.4.2 From the topographical survey that was conducted by 3D Engineering Surveys Limited a network of irrigation mains are adjacent to the Hazelwood irrigation pond. The proposed cable route crosses the irrigation main in three locations. Ownership of these mains is to be understood prior to construction so that they can be protected appropriately.

4.4.3 All known utilities crossings as included in the Sea Link Crossing Schedule, **6.3.1.4.A ES Appendix 1.4.A Crossings Schedules [APP-089]**.

### **4.5 Existing Field Drainage**

- 4.5.1 Locations and details of existing field drainage systems are unknown at this stage and a review of natural overland flow paths on steeply sloping ground has not been undertaken.
- 4.5.2 The Rural Sustainable Drainage Systems (RSuDS) document by the EA states that the average land drain depth is approximately 0.9m where the average drain spacing drain is between 15-30m. A high concentration of field drainage is likely in areas of clay soils, with most systems using mole ploughing drainage techniques. The Suffolk cable route superficial deposits and bedrock are predominant sand, gravel and Diamicton (mainly chalky, pebbly, sandy clay Glacial Till). The agricultural fields where Diamicton is expected to be encountered could have a higher number of field drains than in the sand and gravel grounds, due to the low permeability of the Diamicton deposits.
- 4.5.3 Typical land drainage layouts are shown in Plate 4.1. A field can contain a combination of different layouts or be drained irregularly, depending on the surface slopes across the field. If smaller fields have been merged into one, the outfalls may be found at the low points of each original field and not the current field.

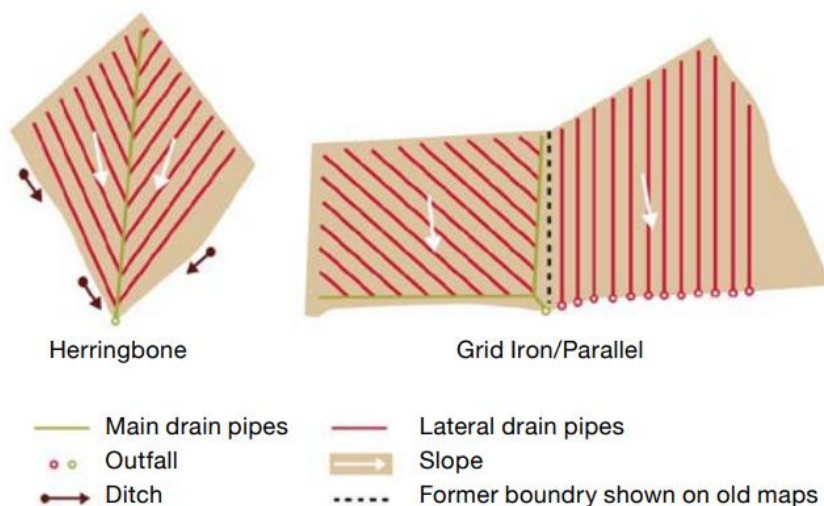

## Plate 4.1 Typical land drainage layouts

Source: Field drainage guide by Agriculture and Horticulture Development Board (AHDB) (2022).

## 4.6 Flood Zones

- 4.6.1 The Flood Risk Assessment document assesses the impact of the proposed development on flood risk from surface water, fluvial, coastal or groundwater sources, or any changes to flood risk in the surrounding areas affected by the Sea Link project. To produce this drainage strategy, a review of the EA flood risk mapping has been considered to ensure that the proposed development does not increase flood risk to

the site or elsewhere and where practicable reduces flood risk over the lifetime of the development. Mapping of flood risk is provided in **6.4.2.4 ES Figures Suffolk Water Environment [APP-231]**.

- 4.6.2 The EA “Flood Map for Planning” indicates that the site is mostly located within Flood Zone 1, and therefore at a low flood risk from rivers and sea. A short section at the landfall end of the cable route sits within Flood Zone 3. This is where the onshore cable route lands from the offshore cable. The jointing bays where the HDD installation from offshore meets the onshore cable are in Flood Zone 1.
- 4.6.3 Jointing bays are underground structures constructed at intervals along the onshore cable route to join cable sections and facilitate cable installation into the buried ducts. All jointing bays along the cable route will be protected from groundwater ingress. Mitigation measures will be introduced to mitigate flood risk during the construction phase of these elements in the **7.5.3 Outline Onshore Construction Environmental Management Plan [APP-340]** (CEMP), that has been developed to avoid, minimise, or mitigate any construction effects on the environment. Mitigation measures in **7.5.3.2 CEMP Appendix B Register of Environmental Actions and Commitments (REAC) [APP-342]** include B09 which provides mitigations relating to “Impacts from potential frac out”.
- 4.6.4 The permanent access road to the new Saxmundham converter station crosses the River Fromus via a new bridge. The crossing has been subject to detailed assessment, as discussed within **6.8 Flood Risk Assessment [APP-292]**.
- 4.6.5 Surface water flooding is often referred to as ‘pluvial’ flooding. This flooding occurs when heavy rainfall exceeds the capacity of local drainage networks, resulting in water flowing across the ground or ponding in low lying areas and localised depressions. Where possible, drainage attenuation basins should not be designed in places in areas of increased risk of surface water flooding (areas of High risk or Medium risk more than 3.3% annual exceedance probability, AEP). Surface water flood mapping for the Suffolk portion of the Scheme is provided in **6.4.2.4 ES Figures Suffolk Water Environment [APP-231]**.
- 4.6.6 Surface water flood zones have been avoided wherever possible, but there are localised areas where areas of potential surface water flooding intersect with the location of the new basins (temporary). This surface water flooding is Medium (between 1% and 3.3% AEP) and Low risk (between 0.1% and 1% AEP) of flooding. The decision to locate the temporary basins in these localised areas follows liaison with the landowner, as it is expected to have less impact on the landowner than alternative options. Basins are to be bunded where appropriate.

## 4.7 Friston Substation Site

- 4.7.1 The Friston substation site sits within the catchment area of the Friston Surface Water Study (dated May 2020), which was commissioned as a part of Suffolk County Councils Local Flood Risk Management Strategy, following flooding in the Friston area. Flooding in the Friston area was the subject of two S19 reports following significant flooding in 2019. The Applicant has reviewed the contents of the S19 reports and the Friston Surface Water Study and has identified no conflicts between the recommendations of the Friston reports aforementioned and the Scheme.
- 4.7.2 In accordance with the drainage strategy of the rest of the Suffolk Scheme, surface water discharged from the impermeable areas of the Friston site is to be fully infiltrated into the ground. No surface water runoff from Friston site will be discharged into existing ditches and watercourses, which reduces the schemes impact on local flood risk.

## 5. Existing Ground Conditions

5.1.1 The existing ground conditions are described in the DCO application in **6.3.2.5.D ES Appendix 2.5.D Ground Investigation Report – Suffolk [APP-199]**.

5.1.2 The four reports listed below are taken as a reference for the assessment of this section, and the first three items in the list were used to form the Ground Investigation Report referenced above:

- Onshore Geotechnical and Geo-Environmental Ground Investigation, Factual Report (Structural Soils Ltd, 2022, EA1N-GRD-GEO-REP-SSL-000001 735329-01 REV 21).
- Factual Report on Preliminary Ground Investigation (Structural Soils Ltd, 2024, Report No.: 563835-01 (03)).
- Geotechnical and Geo-environmental Preliminary Risk Assessment (Desk Study) Report – Friston” (Mott MacDonald, 2022, SEAL-MMD-SEAL-ENG-REG-0056).
- Summary of Infiltration Testing Technical Note (SPR, 2025, Report ID.: EA2-ONC-GEO-TEC-IBR-000002)

### 5.2 Geology

5.2.1 The scheme crosses agricultural land with a flat lying topography.

5.2.2 The British Geological Survey (BGS) 1:50,000 mapping indicates the scheme is underlain by the Crag Formation (CRAG) with a varying thickness of Lowestoft Till Formation (Glacial Till) which is predominantly sand and gravel, with Diamicton (mainly chalky, pebbly, sandy clay Glacial Till) and minor silt and clay along sections of the cable route at higher elevations. In localised areas where there is no superficial cover, the cable route will lie within the Crag Formation.

5.2.3 The following high-level summary of the anticipated geology is taken from the Structural Soils Ltd Factual Report on Preliminary Ground Investigation dated 2024:

#### Superficial geology

- Tidal Flat Deposits: Mapped only at the eastern end of the site, near the coastline.
- Marine Beach Deposits: Mapped only at the eastern end of the site, along the coastline.

- Lowestoft Formation: An extensive sheet of chalk till, with outwash sands, gravels, silts and clays. Characterised by its chalk and flint content.
- Alluvium: Clay, silt, sand, gravel. Mapped along the course of the River Fromus which is aligned north-south to the east of Saxmundham.

### **Bedrock Geology**

- Crag Group: Mainly sand however can have gravel, silt and clay beds. Predominantly medium to coarse grained, shelly at base. Strongly iron-stained at surface, locally green at depth.
- Coraline Crag Formation: Carbonate-rich skeletal sands. moderately- to poorly sorted medium-grained sand, the mud content is low. Basal lag gravel rich in pebbles of phosphatic mudstone largely derived from the Thames Group.
- Thames Group (London Clay Formation and Harwich Formation): Clay, silty, blue grey. Bioturbated silty clays and sandy clayey silts.

### **Made ground**

- Made ground encountered along the cable route is approximately 0.5m deep.

5.2.4 Refer to Appendix C for the BGS Mapping with the cable route.

## **Permeability**

5.2.5 Permeability of the ground influences whether the drainage strategy for the scheme can incorporate infiltration as a method for disposal of surface water flows.

5.2.6 The permeability assessment of the scheme considers the following three GI reports that cover the entire GI works along the Sea Link scheme:

- The Onshore Geotechnical and Geo-Environmental Ground Investigation, Factual Report (Structural Soils Ltd, 2022, EA1N-GRD-GEO-REP-SSL-000001 735329-01 REV 21) include the GI for the future Friston substation.
- The Factual Report on Preliminary Ground Investigation (Structural Soils Ltd, 2024, Report No.: 563835-01 (03)) covers the following:
  - The GI works located southeast of Saxmundham, which is the proposed location of the new Saxmundham converter station, and
  - the rest of the GI works which are from the landfall point at the Aldeburgh beach to the future Friston substation.

- Summary of Infiltration Testing Technical Note (SPR, 2025, Report ID.: EA2-ONC-GEO-TEC-IBR-000002) covers Infiltration rates surrounding future Friston Substation

### **Analysis of Factual Report on Preliminary Ground Investigation (Structural Soils Ltd, 2024, Report No.: 563835-01 (03))**

- 5.2.7 The Soakaway tests were undertaken in trial pits F22-TP204A, F22-TP312A, F22-TP313A, F22-TP316A, F22-TP317A, F22-TP404A, F22-TP406, and F22-TP513A in general accordance with recommended practice given in BRE Digest 365. Also, permeability tests were instructed in 4 boreholes that were dry (no standing groundwater level) at time of tests. See Table 5.1 with the soakaway test results. Refer to Appendix C for the location of the soakaways used in the current design.
- 5.2.8 The soakaway tests have been used to size the infiltration basins adjacent to the Hazlewood Reservoir and the infiltration basin for the HDD crossing compound.

**Table 5.1 Permeability test from GI 2024**

<b>TRIAL PIT OR BOREHOLE LOCATION</b>	<b>PERMEABILITY (M/S)</b>
TP404A BRE Digest 365	$1.52 \times 10^{-4}$ m/s 1.3m SAND (LOWESTOFT FORMATION)
TP513A BRE Digest 365	$2.34 \times 10^{-4}$ m/s 0.9m SAND (LOWESTOFT FORMATION)

Source: Factual Report on Preliminary Ground Investigation (2024). Soakaway tests listed above are within Appendix E.

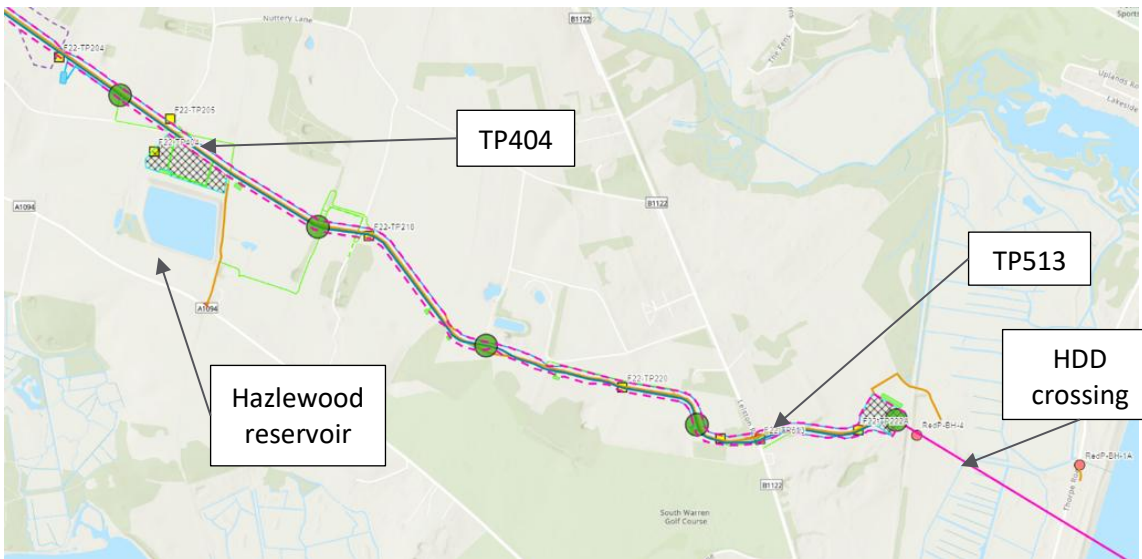

**Plate 5.1 Trial pits and boreholes from the GI dated 2024**

Source: Factual Report on Preliminary Ground Investigation (2024)

**Analysis of Ground investigation (Structural Soils LTD, 2022, EA1N-GRD-GEO-REP-SSL-000001 Rev 21)**

5.2.9 A ground investigation produced by Scottish Power Renewables (SPR) for a cable route East Anglia TWO Offshore Windfarm project has been used to produce the drainage strategy at Friston substation. There is coverage of recently completed boreholes and infiltration tests at the Friston substation site. See Appendix C for the GI locations by SPR and Superficial and Bedrock Geology within the cable route. The orange dots indicate trial pits by SPR, where some infiltration testing was carried out in accordance with BRE Digest 365. Infiltration test results obtained within the extents of the Lowestoft Formation Sand and Gravel indicate an infiltration rate of approximately  $1 \times 10^{-5} \text{m/s}$ , as per trial pits TP012B to TP017B located in the proposed Friston substation where the superficial deposits Lowestoft Formation Sand and Gravel have depths greater than 4.5m.

5.2.10 The ground investigation report states that it was not possible to complete the infiltration tests. Due to low rates of infiltration, as well as time and safety constraints, it was not possible to complete three repeat fillings, each achieving 75% effective drainage at all locations. All soakaway tests results are in Appendix E.

**Analysis of Infiltration Testing Technical Note (SPR, 2025, Report ID.: EA2-ONC-GEO-TEC-IBR-000002)**

5.2.11 An infiltration testing technical note was produced by SPR to summarise the infiltration testing results undertaken by Structural Soils

Ltd in 2021 and then AECOM in 2024. The technical note outlines that the average infiltration rates around the proposed Friston substation infiltration pond increased by 430% from the 33mm/hr measured in 2021 to 142mm/hr measured in the 2024 tests. The technical note states that this increase is because of the targeted nature of the 2024 infiltration testing, with test locations aligning with the proposed SuDS locations, and depths of testing aligned with the proposed basin depth.

- 5.2.12 This increase in infiltration rates identified in the technical note provides justification for adopting a solely infiltration-based approach for the discharge of surface water from the proposed development, consequently eliminating the previous design of an infiltration pond with an overflow outfall. Infiltration does not create surface water runoff and is therefore the preferred solution for drainage discharge for the development.
- 5.2.13 Additional infiltration testing is planned for the end of 2025 by SPR to support the drainage design and assess the suitability of the basin location.

**Table 5.2 Permeability test from GI 2022**

<b>SOAKAWAY TEST</b>	<b>PERMEABILITY (M/S)</b>	<b>NUMBER OF TESTS / DRAINAGE ACHIEVED</b>
TP017B BRE Digest 365	4.5m SAND (LOWESTOFT FORMATION) 1.39x10-5 m/s	3 Tests / 75% effective drainage achieved

Source: Onshore Geotechnical and Geo-Environmental Ground Investigation Report (2022). Soakaway tests listed above are within Appendix E.

**Table 5.3 Infiltration Rates from SPR Technical Note 2025**

<b>SOAKAWAY TEST</b>	<b>TEST NUMBER</b>	<b>INFILTRATION RATE 2024 GI (mm/hr)</b>
IT001 BRE Digest 365	1	75.24
	2	69.12
	3	61.92
IT003 BRE Digest 365	1	308.52
	2	303.48
	3	240.12
IT004 BRE Digest 365	1	558.00

<b>SOAKAWAY TEST</b>	<b>TEST NUMBER</b>	<b>INFILTRATION RATE 2024 GI (mm/hr)</b>
	2	90.72
	3	99.72
IT005 BRE Digest 365	1	813.60
	2	579.60
	3	630.00
IT006 BRE Digest 365	1	637.20
	2	367.20
	3	346.32
IT007 BRE Digest 365	1	297.00
	2	193.32
	3	160.20
IT008 BRE Digest 365	1	84.24
	2	69.12
	3	65.88

Source: Summary of Infiltration Testing Technical Note SPR, 2025. Soakaway tests listed above are within Appendix E.



**Plate 5.2 SPR GI locations**

Source: NGFD - South Coast Reinforcement GIS by Mott MacDonald (2024) and onshore Geotechnical and Geo-Environmental Ground Investigation Report (2022).

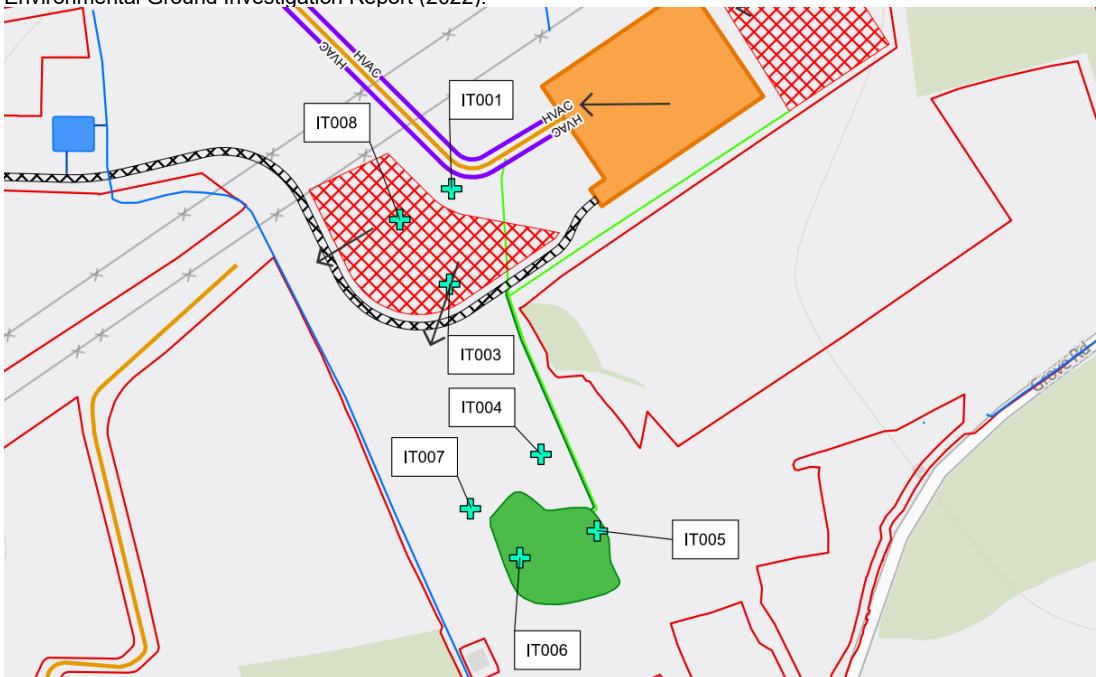

Source: NGFD - South Coast Reinforcement GIS by Mott MacDonald (2025) and summary of Infiltration Testing Technical Note SPR, 2025.

## 5.3 Contaminated Land

- 5.3.1 A review of the Geotechnical and Geo-environmental Preliminary Risk Assessment (Desk Study) Report – Friston” (Mott MacDonald, 2022, SEAL-MMD-SEAL-ENG-REG-0056) indicates that no significant source of contamination has been identified at the location of the proposed converter station or substation site, or across most of the cable route corridor route. The most notable sources of potential contamination include historical clay/sand pits, a historical railway line crossing the route, and the off-site Sizewell Nuclear Power Station. Existing minor contamination has been identified (no exceedances/significant concentrations identified in a high-level review), including low level concentrations of PAH (polycyclic aromatic hydrocarbons) and TPH (total petroleum hydrocarbons) in shallow soils and groundwater.

## 5.4 Groundwater and Source Protection Zones (SPZ)

- 5.4.1 Given the shallow excavation depths proposed (between 1.2m and 3m for cable trench and jointing bays installation) and small scale of the below-ground infrastructure, it is not anticipated that groundwater will be encountered in most of the cable trench excavations.
- 5.4.2 The proposed cable route sits within the catchment area of SPZs) but does not cross the Outer Protection Zone (Zone II) or the Inner Protection Zone (Zone I).
- 5.4.3 A groundwater assessment of the cable route is provided in Section 6.8 of this report, and a risk assessment is provided in **6.3.2.5.B ES Appendix 2.5.B Qualitative Groundwater Risk Assessment [APP-177]**.
- 5.4.4 The Factual Report by Structural Soils Ltd, 2024 describes the existing groundwater as follows:

### **Soil properties in the landfall location:**

- No groundwater encountered in the TPs.
- BH4 indicates groundwater at 1.5mbgl.
- The groundwater in the HDD crossing compound area is indicated by BH4.

### **Soil properties in area from landfall location to new Friston substation:**

- No groundwater encountered in the TPs.
- BH203 indicates groundwater at 5.5mbgl.

### **Soil properties in Saxmundham converter station:**

- No Groundwater encountered in the TPs.
- BH307 indicates groundwater at 8mbgl, BH310 indicates groundwater at 13.6mbgl,
- The groundwater in the converter station footprint area is indicated by BH310 and BH307.

- The groundwater in the River Fromus areas is indicated by the BH 501 and 502. BH501 indicates groundwater at 2mbgl, BH502 indicates groundwater at 1.5mbgl.

# 6. Surface Water Drainage Design Strategy

## 6.1 Overview

6.1.1 This section gives the detailed drainage design strategy for each component of the scheme. These principles have been followed to produce preliminary drainage design. Details are summarised in Appendix A and drawings showing the design can be found in the Appendix B.

## 6.2 Design Guidance and Policy

6.2.1 The drainage strategy for the proposed development has been developed based on the following guidance:

- Flood and Water Management Act 2010 8;
- National Planning Policy Framework (NPPF25) 9;
- The SuDS Manual (C753) 10; and
- Generic Electricity Substation Design Manual for Civil, Structural and Building Engineering:
  - Section 01 Oil Containment (TS 2.10.01);
  - Section 09 Site Drainage (TS 2.10.09);
  - Section 13 Flood Defences for Electricity Substations (TS 2.10.13).
- SCC Local SuDS Guidance (March 2023)<sup>11</sup>
  - For assessing water quantity, SCC LLFA's preferred method for calculating greenfield runoff rates is the FEH methodology.
  - Trial pits are to be carried out across schemes to BRE365 methodology with a minimum infiltration rate of 10mm/hr if infiltration is to be the sole method of drainage.

---

<sup>8</sup> Flood and Water Management Act 2010 (2010). [Online]. <https://www.legislation.gov.uk/ukpga/2010/29/introduction> [Date Accessed: September 2025].

<sup>9</sup> Ministry of Housing, Communities and Local Government (2021). [Online]. Available at: <https://www.gov.uk/government/publications/national-planning-policy-framework--2> [Date Accessed: September 2025].

<sup>10</sup> CIRIA, The SuDS Manual (2015)

<sup>11</sup> Suffolk Local Flood Risk Management Strategy - Suffolk County Council

- Plans to be provided of how surface water runoff is to be managed during the construction phase, including plans of any temporary drainage.
- Temporary SuDS designed and built for the construction phase only must be designed to manage runoffs for all events up to and including the 1in100 (1%) AEP storm (SCC local standard), but no allowance for climate change is required (subject to national climate change guidance) unless construction is intended to take place over a long period of time (i.e., 10+ years).

6.2.2 The NPPF25 guidance outlines how the use of appropriate sustainable drainage systems, or SuDS, can better manage risk of surface water flooding, as well as improving water quality by reducing the amount and rate of water flow by infiltration, storage, attenuation, and slow conveyance. This reduces the volume and rate of surface water leaving the site.

6.2.3 The design proposed seeks to improve the local run-off profile using systems that can either attenuate run-off or reduce peak flow rates on the existing flood profile.

6.2.4 The Department for Environment, Food and Rural Affairs Sustainable Drainage Systems Non-statutory technical standards for sustainable drainage systems expands on this:

- The drainage system must be designed so that, unless an area is designated to hold and/or water as part of the design, flooding does not occur on any part of the site for a 1 in 30-year rainfall event.
- The drainage system must be designed so that, unless an area is designated to hold and/or convey water as part of the design, flooding does not occur during a 1 in 100-year rainfall event in any part of: a building (including a basement); or in any utility plant susceptible to water (e.g., pumping station or electricity substation) within the development.
- The design of the site must ensure that, so far as is reasonably practicable, flows resulting from rainfall in excess of a 1 in 100-year rainfall event are managed in exceedance routes that minimise the risks to people and property.

6.2.5 The Environment Agency requires that there should be no increase in the rate of surface water emanating from a newly developed site above that of any previous development. Furthermore, it is the joint aim of the Environment Agency and Local Planning Authorities to actively encourage a reduction in the discharge of storm water as a condition of Approval for new developments.

## Permanent Works

6.2.6 The permanent works include the normal features of a substation and converter station: transformers, buildings, internal roads, car parks and

external access roads. The substation and converter station design life is 50 years (20 years first life maintenance).

6.2.7 The drainage criteria for permanent work will follow the design stated on the National Grid design document TS 2.10.13:

- 1 in 30-year rainfall event – no flooding on site.
- 1 in 100-year rainfall event – no flooding on operational areas of the site (car parks may flood in this scenario).
- In both 1 in 30-year and 1 in 100-year scenarios, the design shall ensure that excess runoff from the drainage system does not impact adjacent third-party land.
- Where discharge consents or downstream capacity restrictions are in place the design shall restrict flows and incorporate attenuation to achieve the requirement.

#### Temporary Works

6.2.8 Temporary haul road, cable swathe and construction compound works are to be installed for approximately 5 years (which could vary as the construction stage develops).

6.2.9 Suffolk Flood Risk Management Strategy, dated 2023, states ‘Temporary SuDS designed and built for the construction phase only must be designed to manage runoffs for all events up to and including the 1 in 100 (1%) AEP storm (SCC local standard), but no allowance for climate change is required’. Therefore, a 1 in 100-year return period will be applied to all temporary works.

#### Climate Change

6.2.10 The site is located in the East Suffolk Management Catchment. The Environment Agency provides guidance on percentage uplift to peak rainfall intensities that should be allowed for in new developments to account for the effects of climate change.

6.2.11 The proposed climate change allowance for the permanent development drainage scheme is 45%, as presented for the “Upper end allowance” parameter. The flood risk vulnerability classification established for a substation is described as essential infrastructure, for which this parameter should be used. The 2050s epoch is used for the anticipated design life of 50 years (as per National Grid TS 2.10.13 – Flood Defences for Electricity Substations).

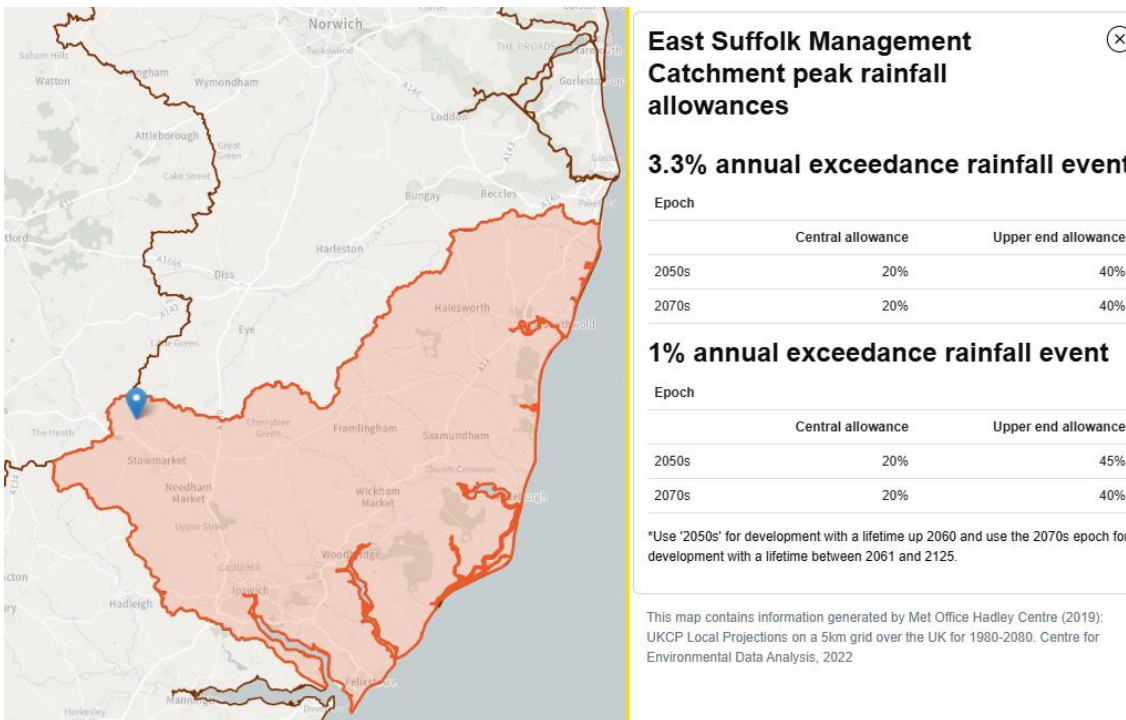

## Plate 6.1 Climate change uplift allowances for peak rainfall

Source: Environment Agency<sup>12</sup> (2024).

### 6.3 Runoff Destination

- 6.3.1 It should be acknowledged that the satisfactory collection, control and discharge of storm water is a principal planning and design consideration.
- 6.3.2 The NPPF states that for new developments, the best way of reducing flood risk within the development is to:
- Control the water at source through sustainable drainage system (SuDS).
  - Consider exceedance flow route when the capacity of the drainage system is exceeded.
- 6.3.3 SuDS should mimic natural drainage and reduce the amount and rate of water flow by:
- Infiltration into the ground,
  - Holding water in storage areas, and
  - Slowing the flow of water.

<sup>12</sup> <https://environment.data.gov.uk/hydrology/climate-change-allowances/rainfall?mgmtcatid=3035>

6.3.4 The design will meet the following discharge hierarchy (with acceptable justification for moving between levels) by the CIRIA C753 SuDS manual:

1. infiltration to the maximum extent that is practical – where it is safe and acceptable to do so
2. discharge to surface waters
3. discharge to surface water sewer
4. discharge to combined sewer (last resort)

6.3.5 The design allows for full attenuation and infiltration or discharge of the runoff from the proposed temporary and permanent works, in line with the design requirements outlined within Section 6.2 of this report. However, there are opportunities within both the temporary and permanent phases of the project to reuse collected water on the site or within the near vicinity, to reduce the quantity of discharged water. Use during construction could include trenchless drilling fluid, dust suppression, wheel washes or use within the welfare units as a non-potable water source. Use during the operational phase could include irrigation, top up of the fire water tank or use within welfare facilities. The Applicant has also held early discussions with interested parties who may benefit from the water being used as a source of irrigation for agricultural land in the near vicinity to the project. The Applicant will continue to explore these opportunities as the detailed design develops.

## **6.4 Management of Extreme Rainfall and Flooding**

6.4.1 The proposed surface water drainage strategy is to replicate as closely as possible the natural runoff characteristics of the existing site, intercepting all flows from the permanent works and temporary works into infiltration or attenuation basins prior to discharging into the nearest watercourse.

### **Post-Development Discharge Rates**

6.4.2 Following the discharge hierarchy of the SuDS guidance described in the previous section, the general strategy is to use infiltration were considered feasible following assessment of the available information on permeability of the ground. Discharge to the nearest watercourse via controlled discharge rate is proposed where infiltration is considered unlikely to be feasible.

6.4.3 Appendix A shows the proposed discharge rate for each attenuation basin.

### **Discharge via Infiltration**

- 6.4.4 The viability of a soakaway or other infiltration system is dependent on the site conditions. Specifically, the infiltration rate of the underlying soil, groundwater conditions, possible contaminants and spatial constraints should all be considered.
- 6.4.5 The permeability of the existing ground and underlying geology for the scheme have been discussed in Section 5; infiltration test results obtained within the extents of the Lowestoft Formation Sand and Gravel indicate infiltration rates that vary from  $2.34 \times 10^{-4} \text{m/s}$  to  $9.33 \times 10^{-6} \text{m/s}$ . In view of the information currently available, it is considered that the use of infiltration could be feasible for the scheme in some areas within the extents of the Lowestoft Formation Sand and Gravel geology.
- 6.4.6 In line with SCC Managing runoff guidance, where shallow infiltration (circa 2m deep) is proposed, all trial pits across the site are to be carried out to BRE365 specification with minimum infiltration rate of 10mm/hr ( $2.77 \times 10^{-6} \text{m/s}$ ) if infiltration is to be the sole method of drainage.
- 6.4.7 Infiltration features should discharge from full to half full within 24 hours for the 3.33% + climate change (cc) AEP storm with space for an additional 10% + cc AEP storm if it exceeds 24 hours so that the risk of it not being able to manage a subsequent rainfall event is minimised. To account for the reduction of infiltration over time (lack of effective pre-treatment and/or poor maintenance), the following factors of safety should be introduced, reducing the recorded infiltration rate. All infiltration basin safety factors are set to 2 along the scheme design, as most of the scheme is located in agricultural land where is expected to be little damage or inconvenience caused by the failure of the infiltration basins.

**Table 6.1 Infiltration factors of safety**

Size of area to be drained (m <sup>2</sup> )	No damage or inconvenience	Minor inconvenience (surface water on car parking areas)	Damage to structures/buildings or major inconvenience (highway flooding)
<100m <sup>2</sup>	1.5	2	10
100-1000m <sup>2</sup>	1.5	3	10
>1000m <sup>2</sup>	1.5	5	10

Source: the SCC Managing runoff guidance.

- 6.4.8 There is to be a minimum of 1.2m clearance between the base of the infiltration feature and the highest groundwater level. Groundwater is encountered at a depth of around 1.5m below ground level in some areas as stated in Section 5.4.

**Table 6.2 Proposed full infiltration areas**

<b>PROPOSED FULL INFILTRATION BASINS</b>	<b>CATCHMENT TYPE</b>	<b>LOCATION / GEOLOGY DESCRIPTION</b>
TC-20-INPN (Temporary Basin)	HDD Construction Compound and HVDC Cable Swathe	Adjacent to North Warren Nature Reserve / Chillesford Church Sand Member - Sand
TC-21(Temporary Basin)	HVDC Cable Swathe	Golf course / Lowestoft Formation – Sand and Gravel
TC-22 (Temporary Basin)	HVDC Cable Swathe	Golf course / Chillesford Church Sand Member - Sand
TC-23 (Temporary Basin)	HVDC Cable Swathe	Golf course / Chillesford Church Sand Member - Sand
TC-24 (Temporary Basin)	HVDC Cable Swathe	Golf course / Chillesford Church Sand Member - Sand
TC-25 (Temporary Basin)	HVDC Cable Swathe	Hazelwood Reservoir / Lowestoft Formation – Sand and Gravel
TC-26 (Temporary Basin)	Construction Compound and HVDC Cable Swathe	Hazelwood Reservoir / Lowestoft Formation – Sand and Gravel
TC-30 (Temporary Basin)	Construction Compound and HVDC Cable Swathe	North of Friston / Lowestoft Formation – Sand and Gravel
TC-36 (Temporary Basin) Infiltration rate of $1 \times 10^{-5} \text{ m/s}$ measured and discharge rate of 5.03l/sec.	HVAC cable swathe, HVDC cable swathe, and two temporary compounds that serve the new Friston substation	Friston Substation / Lowestoft Formation – Sand and Gravel
PC-01 (Permanent Basin)	Friston substation and its permanent access road	Friston Substation / Lowestoft Formation – Sand and Gravel

Source: Appendix A. Notes: TC: Temporary Catchment.

- 6.4.9 The TC-36 Temporary Infiltration Basin serves the two laydown areas associated with the construction of the new Friston substation and its haul roads, and a section of the HVAC and HVDC cable swathe. The TC-36 is designed to store and infiltrate the rainfall of the 1 in 100-year storm event.
- 6.4.10 The PC-01 Permanent Infiltration Basin serves the new 400kV Friston substation compound and its permanent access road. The TC-36 is designed to store and infiltrate the rainfall of the 1 in 100y + 45 CC storm event.

### **Discharge to a Watercourse**

- 6.4.11 The hydrology of the scheme is discussed in Section 4 of this report. Following the hierarchy of the SuDS guidance, where it is not possible to infiltrate into the ground, discharging to the closest watercourse at a restricted discharge rate is proposed.
- 6.4.12 Discharge rates to receiving watercourses are based on the estimated 'greenfield' run-off rate (Qbar) for the undeveloped site in accordance with Suffolk County Council guidance.
- 6.4.13 The proposed discharge rate shall be controlled by a Hydrobrake manhole or an orifice control equating to the Qbar discharge rate. The advisable minimum Hydrobrake control rate is 2l/s to avoid blockages. If an orifice control is used, it would be installed in a catchpit with an overflow to mitigate the risk of blockages.
- 6.4.14 Constructing a new outfall to the river would require the applicable consent from the Environment Agency, IDB or LLFA.

### **Estimated Storage Volumes**

- 6.4.15 The MicroDrainage Source Control Module has been used to provide an initial estimate of attenuation storage volume that would be required to limit run-off from the site to the proposed post-development discharge rate as shown in Appendix A. MicroDrainage Source Control Module has been used to calculate the volume of runoff from each catchment identified in Appendix A.
- 6.4.16 The method to produce the drainage calculations has used the following input data:
- The proposed catchment areas have been extracted from the scheme plans and assigned the appropriate design criteria (for temporary and permanent design).
  - A catchment is an area with a natural boundary (for example ridges, hills or mountains) where all surface water drains to a common

channel to form rivers or creeks. The drainage catchments are established by the creation of an alignment along the centre line of the cable route. This alignment incorporates the Lidar and OS terrain data. The alignment identifies high points and low points along the route. Catchments are also bounded by existing roads, railway lines and watercourses.

- Catchment descriptors have been imported from the UK Centre for Ecology and Hydrology (CEH) Flood Estimation Handbook (FEH) for three catchments, see Appendix C. This FEH data has been used to obtain  $Q_{bar}$  in accordance with SCC Local SUDS Guidance dated March 2023. FEH Catchment descriptors used are listed below:
  - FEH\_Catchment\_Descriptors\_646850\_258300 (East and Northeast)
  - FEH\_Catchment\_Descriptors\_643050\_257850 (South of the site)
  - FEH\_Catchment\_Descriptors\_638850\_261350 (West of the site)
- The discharge rates have been associated to each catchment area according to the impermeable area of each catchment following the criteria for the post-development discharge rate  $Q_{bar}$ .
- Point descriptors for runoff rate estimation have been imported from the UK Centre for Ecology and Hydrology (CEH) Flood Estimation Handbook (FEH) in three locations to provide representative rainfall prediction throughout the scheme, see Appendix C. FEH data is used to estimate the rainfall depths and volumes in accordance with the requirements of National Grid guidance TS 2.10.09 and SCC Local SUDS Guidance dated March 2023. FEH point rainfall used for the rainfall is listed below:
  - FEH point rainfall 646965-259182 (For temporary basins)
  - FEH point rainfall 641430-261465 (For permanent basins near the substation)
  - FEH point rainfall 639361-262567 (For permanent basins west of the cable route)

## Proposed Surface Water Drainage Networks

6.4.17 The strategy of the drainage is established via three independent networks as per the quality of the water to be collected:

**Table 6.3 Independent networks forming drainage strategy**

Temporary “dirty water” drainage network	Temporary/Permanent “clean water” drainage network	Permanent surface water drainage network
Runoff from temporary features during the construction stage is considered “dirty water” due to the possibility of contamination with oils and silts. The design will include pollution controls and treatment, and the contractor will implement suitable mitigation measures to manage this risk during construction.	Greenfield runoff from existing overland flows that are intersected by the substation, compound platform, access roads, cable swathe and construction compounds is considered “clean water”. These will be intercepted by swales to discharge to the nearest watercourse without flow restriction.	Runoff from the permanent features considers surface water drainage of the substation plot, including transformers, buildings and internal roads, and the external access road.

### Temporary Works

6.4.18 It should be noted that all temporary features described in this section will be removed post scheme construction and reinstated to the previous agricultural land use.

### Construction compound sites

6.4.19 Construction compounds associated with the onshore works may include areas of hardstanding, lay down and storage areas for construction materials and equipment, areas for vehicular parking, welfare facilities, wheel washing facilities, workshop facilities, and temporary fencing or other means of enclosure. Where necessary, construction compounds will utilise subbase storage as part of attenuating the flows. Construction compounds have been assumed to be 70% impermeable within their gross site areas. Soil bunds surrounding the compounds have been excluded from the compound drainage design. Any fueling areas within the compound will be bunded and runoff managed separately.

**Table 6.4 Overall % PIMP (Percentage of Impervious Area) values for a typical cable construction layout**

Individual catchment	Hardstanding areas (m <sup>2</sup> )	% PIMP
Road / parking / cabins	13337	100%

Individual catchment	Hardstanding areas (m <sup>2</sup> )	% PIMP
Type 3 gravel pavement: plant / fuel tank storage, crane platform	2699	30%
Laydown area: compacted soil	4185	20%
Spoil area: compacted soil	2279	20%
<b>TOTAL</b>	<b>22500</b>	<b>70%</b>

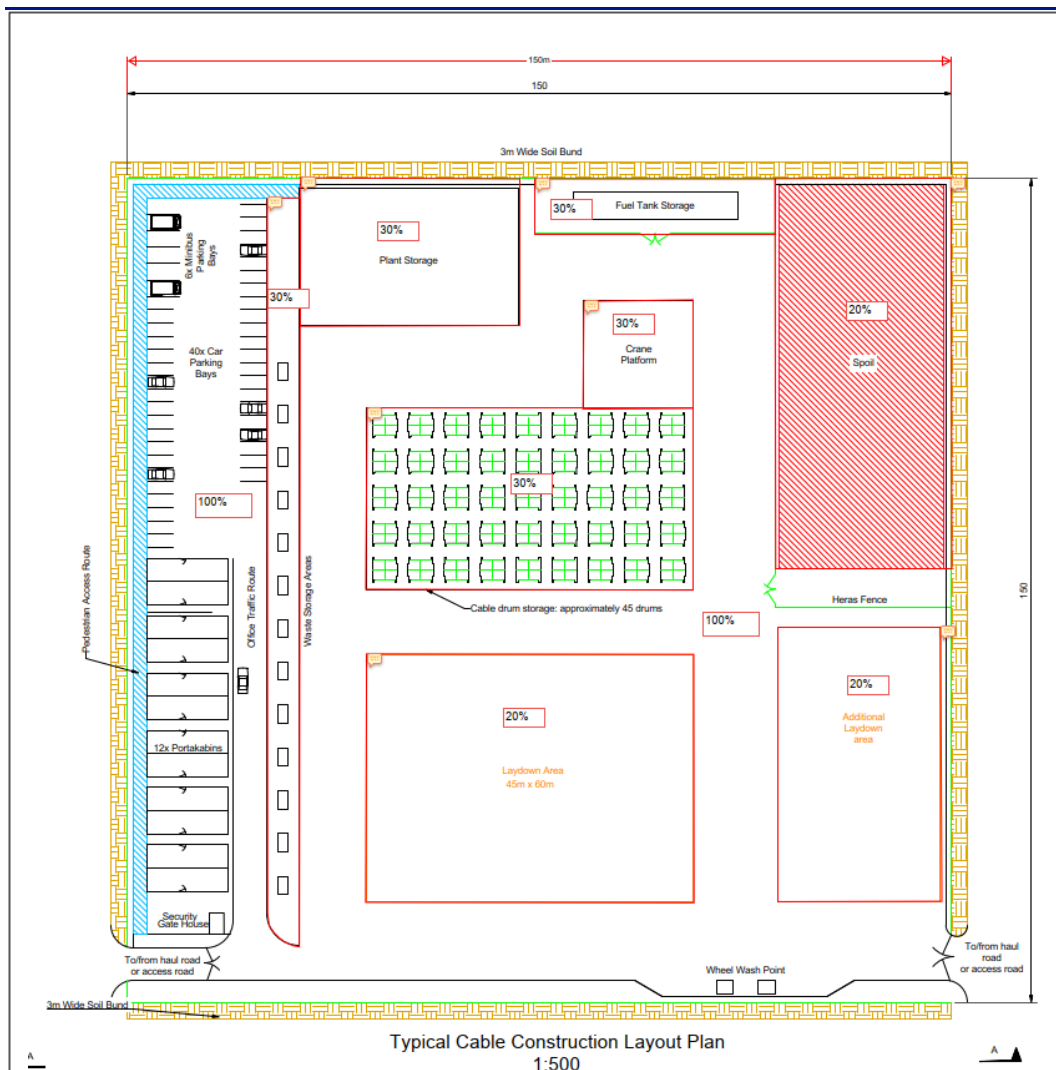

## Plate 6.2 PIMP values for a typical cable construction layout

### Haul Roads

6.4.20 The haul road runs the length of the proposed cable route and is to be constructed from unbound granular material. There is potential for geogrid layers or other type of soil additives to be used for stabilisation. They are considered 100% impermeable.

- 6.4.21 The proposed development considers the haul road to access the construction compound and haul roads within the cable route. Haul road impermeable catchment areas have been based on an average haul road width of 7m.
- 6.4.22 It is proposed that a “dirty” channel drain along the edges of the haul road will collect runoff from the haul road and reduce any possible pollutants draining into the ground during construction of cable trenches. This channel drain will discharge into proposed attenuation basins which include a treatment element to clean anticipated pollutants from the road. In order to locate the proposed attenuation basins to drain the haul roads, the haul road has been subdivided into sections based on the existing longitudinal ground profile and anticipated low points along the route. Attenuation basins have been sized based on these subdivisions and a further review is required once the vertical geometry of the haul road is confirmed at next design stage, which may increase or decrease the sizes of basins required. The new attenuation basins discharge into existing watercourses via a control device to a reduced runoff rate as described in Section 6.6.
- 6.4.23 Dimensions of watercourse crossings were based on a topographical survey conducted by 3D Engineering Surveys Limited Dec 2023.
- 6.4.24 Where a haul road crosses a watercourse, it is proposed that Ordinary Watercourses are culverted and Main Rivers are bridged, as agreed in the recent stakeholder meetings (see Section 1.3). Further detail of culverting/bridging is in Section 6.6.

#### **HVDC and HVAC routes during construction**

- 6.4.25 The proposed HVDC construction swathe is 40m width, and the proposed HVAC construction swathe is 63m width, see **2.13 Design and Layout Plans [APP-037]**. The construction/installation of cables in underground ducts requires stripping back and stockpiling of topsoil within a 40m or 63m wide swathe along the length of the cable route before installation of the ducts within the trenches. There is potential for surface water runoff to be created in significant rain events and become concentrated flow (depending on gradient directions) along the windrow topsoil stockpiles. There is likely to be suspended solids in the runoff which needs to be managed so as not to ‘pollute’ watercourses. During the installation of the ducts, the trenches could fill with water and the ground may therefore need to be dewatered. Suitable settlement processes will be required for the pumped water to remove suspended solids.
- 6.4.26 The swathe contains a haul road of 7m width centered in the swathe. The remainder of the proposed 40m and 63m wide construction swathe has been assumed to be largely permeable, but an extra impermeable area is added for the cable swathe to reduce the potential for impacts associated with changes to surface water runoff and flood risk during construction. The cable swathe will be bunded using the spoil excavated during the installation of the below ground cables. This has the potential to interrupt natural flow paths in some locations. Header drains will collect this “clean” surface water and direct it to the nearest watercourse.
- 6.4.27 The cable trenches are located within the HVDC and HVAC construction swathes. The cable trenches require drainage during construction only, when the ground on top of the trenches is not yet re-instated. Any water that could enter the trenches will be pumped to the attenuation/infiltration basins that drain the construction swathe. Attenuation/infiltration basins are proposed along the cable swathe.

6.4.28 HVDC construction swathes are to be 25% impermeable within their gross site area. HVAC construction swathe to be 20% impermeable within their gross site areas. See below tables for derivation.

**Table 6.5 Overall % PIMP values for HVDC construction swathe**

INDIVIDUAL CATCHMENT	HARDSTANDING AREAS WIDTH (M)	% PIMP
Haul road	7.0	100% (worst case assumed)
Cable trench	7.4	20% (assumed)
Topsoil / stockpiles	25.6	0%
<b>TOTAL</b>	<b>40.0</b>	<b>25%</b>

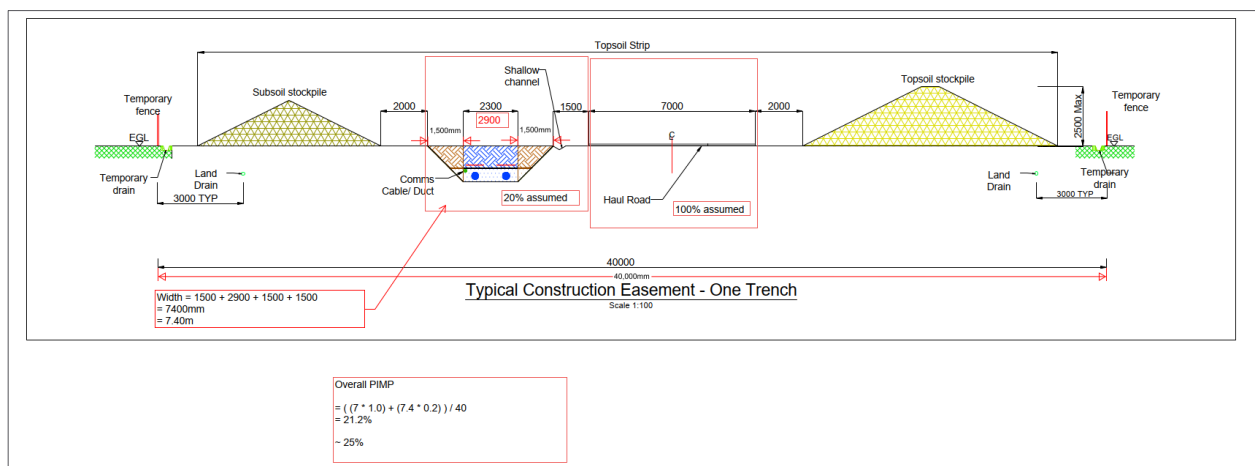

**Plate 6.3 Overall % PIMP calculations for HVDC construction swathe**

**Table 6.6 Overall % PIMP calculations for HVAC construction swathe**

INDIVIDUAL CATCHMENT	HARDSTANDING AREAS WIDTH (M)	% PIMP
Haul road	7.0	100% (worst case assumed)
Cable trenches	13.9	20% (assumed)
Topsoil / stockpiles	42.1	0%
<b>TOTAL</b>	<b>63.0</b>	<b>20%</b>

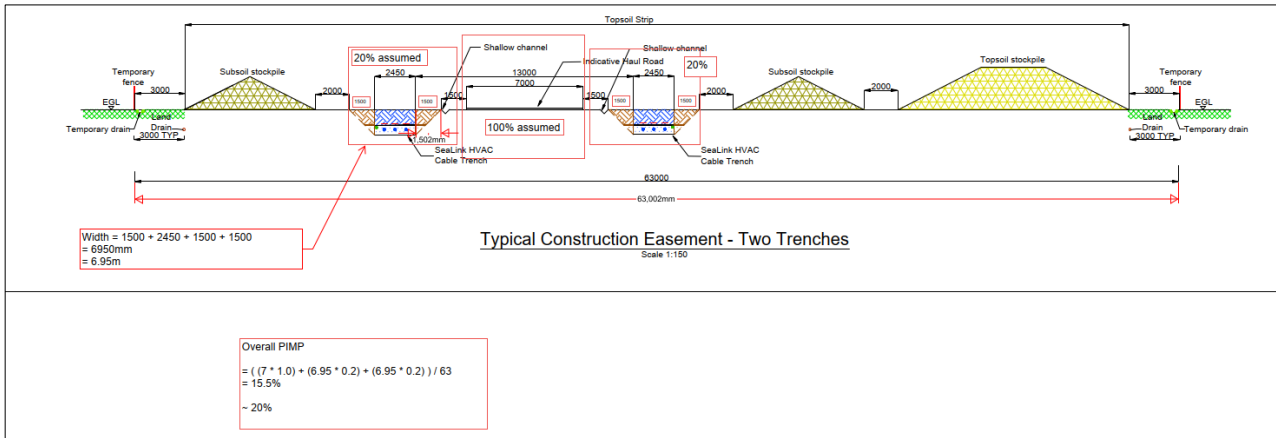

## Plate 6.4 Overall % PIMP calculations for HVAC construction swathe

### Jointing Bays and Transition Bay

- 6.4.29 Jointing bays for HVDC cables are underground structures constructed at intervals along the onshore cable route to join sections of cable and facilitate installation of the cables into the buried ducts. Transition bays are underground structures at the landfall that houses the joints between the offshore export cables and the onshore cables. Jointing bays for HVAC cables are above ground link pillars. All are considered 100% impermeable.
- 6.4.30 The jointing bays and transition bays have been added into the contributing impermeable area of the site. It is assumed that a sump will be provided to remove any water during construction. This sump will discharge into an attenuation/infiltration basin connected to an existing ditch/watercourse.
- 6.4.31 All jointing bays along the cable route which will be protected from groundwater ingress and are not expected to contribute to any localised increased risk of flooding.

### Overland Flow Routes

- 6.4.32 For sites on steep slopes or where overland flows of surface water are known to present issues locally, even if this hasn't been identified on national pluvial flood mapping, an allowance should be made for this within the location and design of SuDS features (e.g., including interception features to safely divert flows).
- 6.4.33 Greenfield runoff from existing overland flow routes will be intercepted by clean header drains and discharged to the nearest watercourse, or will be intercepted by filter drains that infiltrate into the ground if the ground permeability is favourable; this drainage is considered for the temporary and permanent cases:
- The temporary "clean water" drainage network captures the greenfield runoff from existing overland flow routes that intersect the works during construction stage (cables swathe and temporary haul roads) and will be intercepted by clean header drains and conveyed to the nearest watercourse without flow restriction.
  - The permanent "clean water" drainage network captures the greenfield runoff from existing overland flow routes that intersect with the permanent features during operational stage (substation, converter station and permanent access roads) and will be intercepted by clean header drains and conveyed to the nearest watercourse without flow restriction.

- 6.4.34 The overland flows will discharge directly to the outfalls that drain the construction swathe, but they are not flow restricted, consequently the connection will be downstream of the proposed Hydrobrake or orifice flow control.

## Permanent Works

### Drainage in the permanent substation and converter station

- 6.4.35 The surface water drainage strategy for the new converter station and substation will be heavily informed by the Flood Risk Assessment (volumes to be quantified) and information fed in from the LLFA (SCC). The current drainage design of the converter station and substation considers the station plot only.
- 6.4.36 This report considers estimating the volume of attenuation storage required for the scenario where the site is partially permeable (60% of the footprint permeable).
- 6.4.37 The finished platform level is proposed to be stone surfacing laid in accordance with National Grid Design Standards and constructed of a minimum 300mm deep unbound free draining subbase and a minimum 75mm top layer of stone chippings which will where required allow storage of storm water until it can infiltrate into the surrounding soil.

**Table 6.7 Overall % PIMP calculations for Friston substation**

<b>INDIVIDUAL CATCHMENT</b>	<b>HARDSTANDING AREAS (M2)</b>	<b>% PIMP</b>
Roads / parking (tarmac)	3369	100%
Buildings	3324	100%
Type 3 gravel surface	11390	30%
<b>TOTAL</b>	<b>18083</b>	<b>60%</b>

**Table 6.8 Overall % PIMP calculations for Saxmundham convertor station**

<b>INDIVIDUAL CATCHMENT</b>	<b>HARDSTANDING AREAS (M<sup>2</sup>)</b>	<b>% PIMP</b>
Roads / parking (tarmac)	11740	100%
Buildings	16484	100%
Type 3 gravel surface	46776	30%
<b>TOTAL</b>	<b>75000</b>	<b>60%</b>

### Access roads and bellmouths

- 6.4.38 Permanent access roads are to provide vehicular access to the converter station and substation sites. Access roads will have tarmac surface and they are 100% impermeable.
- 6.4.39 Bellmouths are required to allow vehicles to turn safely at all locations where the temporary haul roads or permanent access roads interface with the existing public highway. There are a number of proposed bellmouths across the scheme of varying

sizes which will be constructed from impermeable material (tarmac) to interface with existing public highways.

- 6.4.40 Runoff from the access roads and bellmouths will be collected via filter drains/ditches along the edge and will be directed to a permanent attenuation basin that discharges to the closest watercourse. To locate the proposed attenuation basins to drain the main access roads, the road has been subdivided into sections based on the existing longitudinal ground profile and anticipated low points along the route.
- 6.4.41 When a permanent access road crosses a watercourse, culverting will be the required option for Ordinary Watercourses and bridging will be the option for Main River as agreed in the stakeholder meetings (see Appendix D). Detail of culverting/bridging are in Section 6.6.

## 6.5 Management of Everyday Rainfall (Interception)

- 6.5.1 The proposed SuDS features shall allow interception of the first 5mm of rainfall for the majority of rainfall events where infiltration rates are suitable, resulting in no runoff from the site into surface water or piped drainage systems where infiltration rates are suitable. Interceptions for the Suffolk section of the Sealink include permeable surfaces, swales infiltration basins and filter drains designed to allow infiltration.
- 6.5.2 The substation platform and laydown areas shall be constructed with permeable material, therefore offering interception of everyday rainfall. The permeable platform construction shall naturally retain runoff, where runoffs will be lost to the soils or the atmosphere.
- 6.5.3 Filter drains with infiltration capabilities and swales, where possible, shall be placed along access roads and bellmouths to intercept everyday runoff. For swales to be suitable for interception they must comply the following as per Standard 2 of the National Standards for SuDS:
- A longitudinal gradient of less than 1:100;
  - At least 500mm of suitable base material;
  - A vegetated base surface area receiving runoff which is 5 times less than the impermeable area it serves, whether lined or unlined;
  - When infiltration capability is greater than  $1 \times 10^{-6}$  m/s and the swale is unlined, it shall be assumed that the vegetated base area of the swale can contribute to an impermeable area of up to 25 times it's size, and
  - Interception shall not be deemed to have been provided for impermeable areas draining to an unlined swale within 5m from the swale outlet, unless the swale is flat and has a slightly raised outlet to create a temporary storage zone to encourage infiltration before runoff takes place.
- 6.5.4 Proposed attenuation basins containing standing water do not offer any interception as per Standard 2 of the National Standards for SuDS, therefore other SuDS approaches have been used to comply with the interception of everyday rainfall, where infiltration rates allow.
- 6.5.5 Table 5.3 indicates that high infiltration rates around Infiltration basin PC-01, which collects surface water from the proposed Friston substation platform and access road. As stated in Standard 2 of the National Standards for SuDS, areas of development that

drain to a detention basin where infiltration rates are greater than  $1 \times 10^{-6} \text{m/s}$  shall be assumed to comply when drained impermeable surface area is up to 25 times the base area of the basin. Infiltration basin PC-01 satisfies both of these requirements, therefore complying with Standard 2, management of everyday rainfall.

## 6.6 Proposed Drainage Features

6.6.1 Drainage features are proposed with consideration to the guidance provided by the LLFA in the document “Suffolk Flood Risk Management Strategy Appendix A” (2023). Typical details for these features are provided on drawing SEAL-MMD-SEAL-ENG-DWG-0817 within Appendix B.

## Proposed Storage Basins

6.6.2 Two types of basins are to be implemented – for construction phase and for operational phase.

- Operational attenuation/infiltration basins only receive clean water from the permanent elements (substation, converter station and its access roads), and they do not have a designated volume for treatment. Any operational basin used for water storage during construction should be protected from the silts occurred during the construction phase.
- Temporary attenuation/infiltration basins receive water from construction compounds and haul roads and have a designated treatment volume. For each basin there will be an area included for settlement of silts.

6.6.3 For the preliminary design a buffer of 5m around the basins is included for access and maintenance and to allow for side slopes. The maximum depth of the basins is restricted to due to the uncertainty of the groundwater table. Proposed basin depths vary from 0.5m to 1m. An assessment of the groundwater and elevation of the site has been carried out to obtain the proposed basin depths. In areas where the elevation is flat and there is proximity to a watercourse, the basin depth is limited to 0.5m to reduce the risk of groundwater flooding; in the rest of the areas where there is no risk of groundwater flooding a general 1m basin depth is proposed.

6.6.4 The proposed infiltration basins are vegetated depressions designed to store runoff on the surface and infiltrate it gradually into the ground with an outflow to an attenuation basin where appropriate. They are dry except in periods of heavy rainfall.

6.6.5 The proposed attenuation basins will be designed with 1:3 slopes (any steeper and they will require stabilisation), vegetated, non-permeable geo-textile or naturally lined with an inlet forebay. This will provide treatment of the runoff by allowing for settlement of silts, heavy metals and the removal of oxygen demanding material.

6.6.6 Where a proposed attenuation/infiltration basin is used for temporary sediment control during construction, a settling basin or vegetated forebay within the main basin should be included to trap sediments and prevent clogging of the main infiltration basin. Sediment traps should be approximately 20% of the pool volume. Where an attenuation basin with a forebay element is retained for the permanent phase, the forebay will be removed at the end of the construction phase.

6.6.7 The general arrangement of the basin used during the construction phase is shown below:

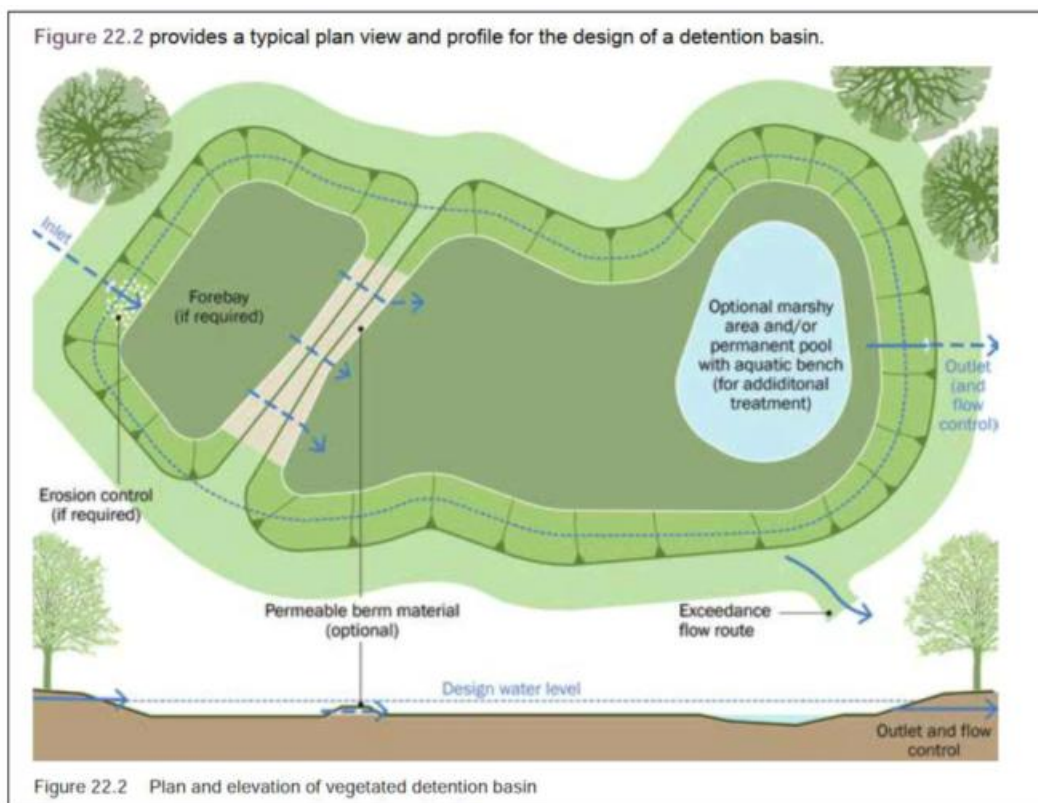

## Plate 6.5 Basin with Forebay detail

Source: CIRIA C753.

6.6.8 The permanent attenuation ponds will be designed to be organic in shape and to be of value for riparian mammals by retaining an earth ledge and sloping bank above a shallow (e.g. minimum 10 cm) permanent water level. The ledge will be planted with emergent riparian vegetation. To reduce harm from deer, the permanently wet sections of the basins will be naturally lined (e.g. clay) rather than using artificial liners as the latter can be damaged by deer.

## Header, Filter Drains and Swales

6.6.9 Header drains are to be used throughout the scheme to intercept clean surface water runoff coming from overland flows (they form part of the Temporary/Permanent “clean water” drainage network as indicated in Section 10345021.0). These drains limit flows from crossing the haul road, construction swathe or construction compounds and becoming silty. They run parallel to the haul roads and access roads; and around the perimeter of the construction compounds, converter stations and substations compounds where required. The overland flows are assumed to be clean and therefore require minimal levels of treatment. Furthermore, the intercepted overland flows will be discharged into the nearest watercourse without restriction to flow.

- 6.6.10 Filter drains or swales are to be used for drainage of the haul road and construction compounds. Any runoff intercepted within the permeable subbase of the construction compounds will be directed to the perimetral swales, as shown on Plate 6.6.
- 6.6.11 They will collect dirty runoff from the haul road/construction compounds and discharge to the temporary attenuation basins along the route. Filter drains or swales used during the construction phase contain any surface water runoff of the compounds and haul roads, therefore preventing any potential pollutants, including silts and fines, entering the surrounding watercourses.

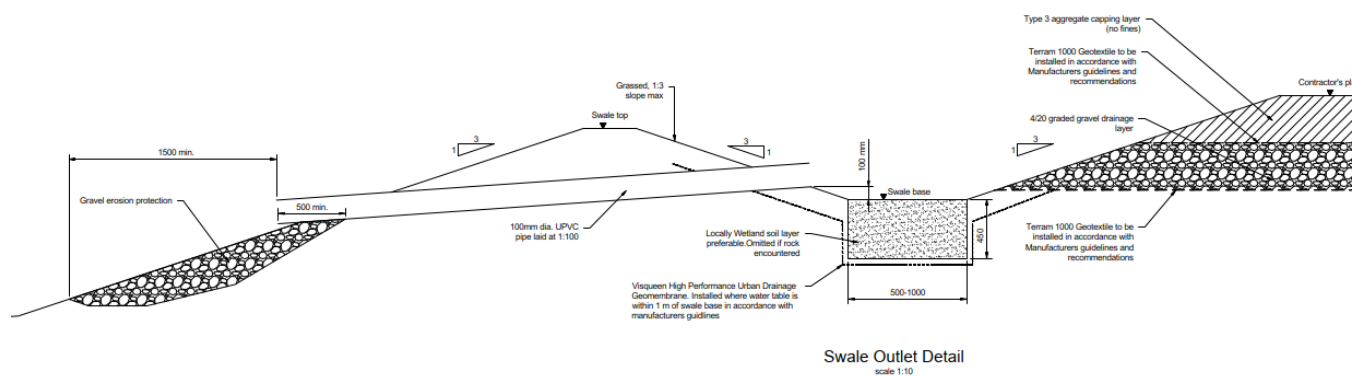

## Plate 6.6 Proposed swale to intercept flows from the permeable subbase of the platforms

Source: Mott MacDonald.

## Outfalls and Headwalls

- 6.6.12 Topographical survey by 3D Engineering Surveys Limited provides the base of the watercourse elevation and top of the embankment of several ordinary watercourses where outfalls are proposed.
- 6.6.13 In order to set up the Invert Level (IL) of each outfall a permanent water level is assumed on each watercourse. Therefore, the outfalls have a minimum vertical distance of 200mm from the (assumed) permanent water level to avoid outfalls being permanently submerged.
- 6.6.14 When topographical survey is not available, LIDAR or OSTerrain5 is used to identify the minimum elevation of the outfalls. It assumed the elevation of the outfall is 0.5m below the elevation provided by the LIDAR or OSTerrain5 data.
- 6.6.15 Appendix A includes recommendations of minimum invert levels for the proposed outfalls (permanent and temporary).
- 6.6.16 In accordance with TS 2.10.09, headwalls shall be provided at all positions where a drainage system discharges into open water. All outfalls to proposed attenuation basins are to be headwalls with a flap valve and all outlets from proposed attenuation basins are to be headwalls with a sluice gate. Scour protection should be provided for permanent and temporary outfalls. Outfalls should be angled at 45° to the water flow; small pipes (less than 300 mm diameter) can be at a maximum of 90° to the flow.
- 6.6.17 Water quality mitigations for discharging to watercourses are explained in Section 8

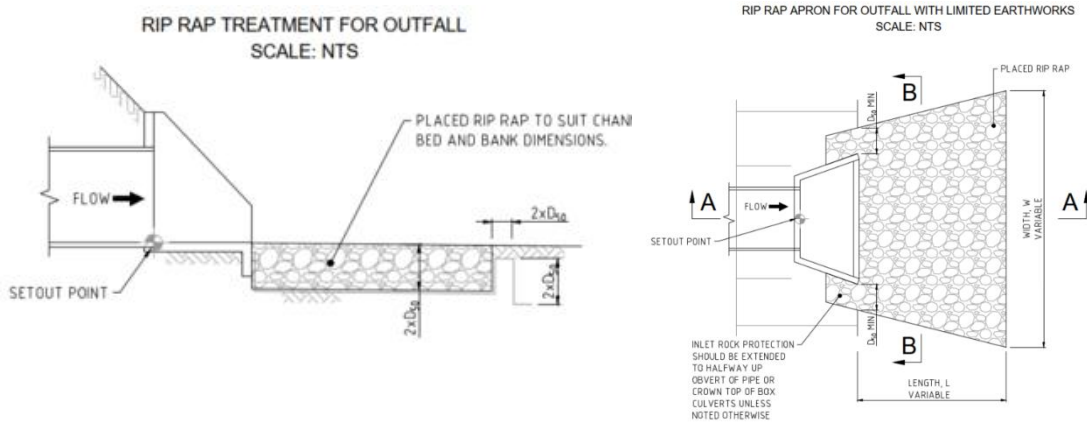

## Plate 6.7 Headwall detail with scour protection for permanent works

Source: Mott MacDonald Ltd

### 6.7 Field Drainage Management

- 6.7.1 Where the existing field drainage is affected by the temporary works and permanent works, the field drainage must be correctly managed with the agricultural owner or manager of the agricultural land affected by the scheme. As stated in Section 5.2, field drainage may be present in areas with Diamicton superficial deposits, where the ground has low permeability capacity. The average depth of the field drains is assumed to be 0.9m as per Section 4.5 of this report, based on the Rural Sustainable Drainage Systems (RSuDS) by the EA that provides a list of existing land management options and guidance for farmers and land managers to install Rural sustainable drainage systems.

#### Affected Field Drainage in Permanent Works

- 6.7.2 The permanent works include the normal features of a substation, converter station and external access roads.
- External access roads are expected to reach a depth between 0.5m and 0.7m depending on ground conditions. The risk of the roads affecting the existing land drainage is low.
  - Substations and converter stations sit on agricultural land. They are formed on top of existing ground on a raised flat platform. Diversion may be required where / if field drainage is affected by the substation and converter station footprint. However, it is anticipated that the risk of the platform affecting the existing land drainage is low.

#### Affected Field Drainage in Temporary Works During Construction Phase

- 6.7.3 Temporary works are haul roads, cable swathe and construction compound works.
- Haul roads are expected to be constructed to a depth between 0.2m and 0.7m depending on ground conditions, but it would vary as per ground conditions. The risk of haul roads affecting existing land drainage is very low.

- Construction compounds sit on agricultural land. They are formed on top of existing ground on a raised flat platform. The risk of the construction compounds affecting the existing land drainage is very low. If any land drains are affected by the footprint of the construction compound, they will be diverted to maintain the continuity of the existing land drainage network.
- The cable trench within the cable swathe will typically be at a depth of approximately 1.5m, where the initial 0.9m depth is suitable backfill material. Land drainage is anticipated to be at 0.9m depth. Any field drainage affected by installation of the cable trench will be diverted during the construction phase. For the permanent phase, it is assumed that any field drainage affected by the cable trench installation will be reinstated within the suitable backfill material layer that sits above the proposed cables as per below figure.

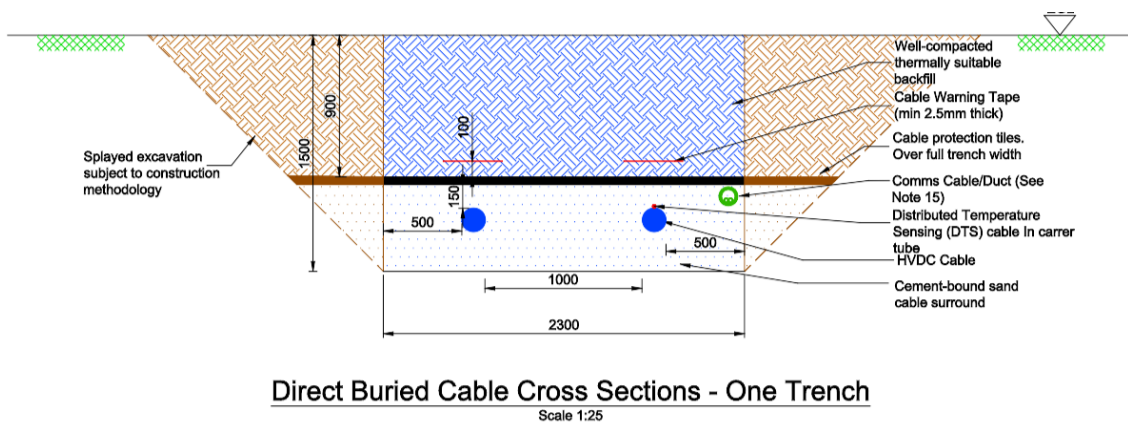

## Plate 6.8 Indicative trench cross section

- 6.7.4 During the installation of the cables, field drainage should be diverted, rather than truncated, to avoid water backing up the system and flooding upstream areas, via header drains. Diverted field drains should discharge to the closest watercourse or via balancing basins if required to mitigate flood risk at receiving watercourses. These balancing basins are not currently included in the drainage design and will need to be addressed at a future stage.

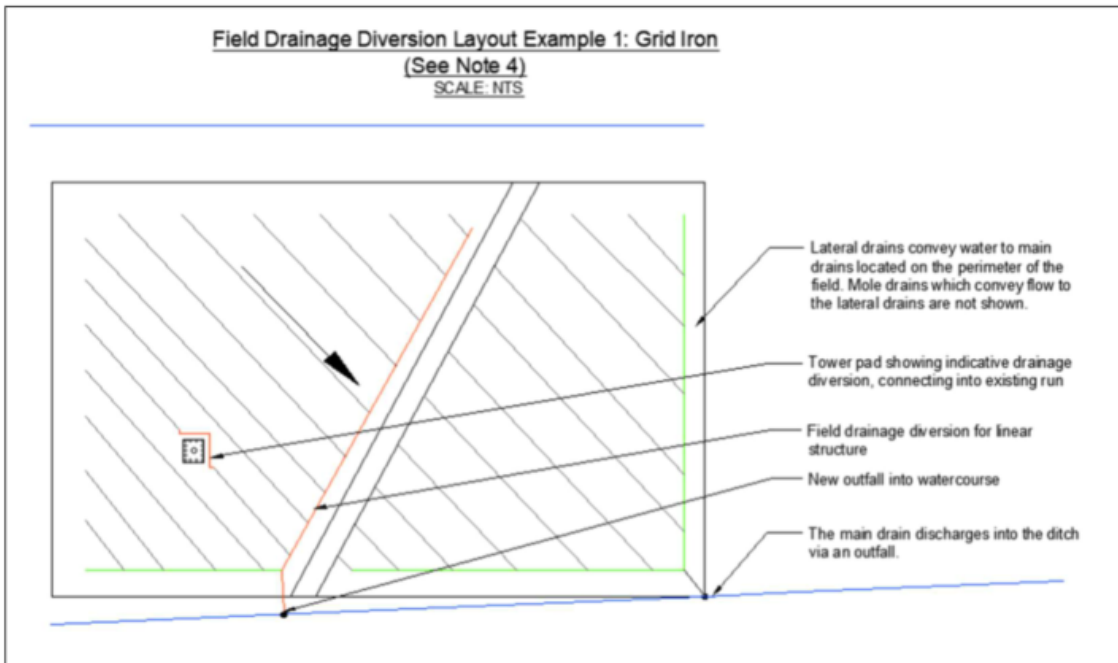

**Plate 6.9 Field drainage diversion layout example**

## New Field Drainage

- 6.7.5 Where it is necessary to install new land drainage, the following guidance will be followed.
- 6.7.6 Newly installed field drains should not drain working areas that have been stripped of topsoil. Where the drains may present a pollution risk, solid (not perforated) pipe should be used and in-line filters and sumps installed, as referenced in CIRIA 648 – “Control of Water Pollution from Linear Construction Projects”.
- 6.7.7 CIRIA 648 notes that the main contractor can be held responsible for the quality of water diverted through the works and discharged from an outfall used during construction. The contractor must therefore be aware of any activities upstream (such as muck-spreading or plough) that may cause polluted water to enter the diverted land drains. In order to avoid polluted water entering into the land drains due to the works upstream the diversion, the contractor should install attenuation/sediment control basins on the line of the diversion, upstream of the receiving watercourse.
- 6.7.8 Affected land drains should be sealed, upslope and downslope, where they cross the site and care taken to ensure that the land upslope will not become waterlogged or flood as a result.

## 6.8 Groundwater Management Features

- 6.8.1 Existing groundwater conditions are stated in the Section 5.4 of this report. If groundwater is encountered during the installation of the cable route, substations, and converter stations the proposed mitigations are described below.

## Cable Trenches

- 6.8.2 The cables will typically be at a depth of approximately 1.5m and held within trenches approximately 1.5m deep and 1.5m wide. The cables will be installed in a UPVC duct, surrounded by sand wrapped in a geotextile, the trenches backfilled and the ground reinstated. Foundation depths have not been confirmed but are expected to be similar to the haul road with a depth between 0.2m and 0.7m depending on ground conditions, but it would vary as per ground conditions.
- 6.8.3 Depending on the porosity of the backfill and the geotextile, the trenches may act as a channel and convey water elsewhere. It is expected that if the hydrogeology indicates its necessary this can be managed through mitigations outlined in site specific hydrogeological risk assessments, such as the use of regularly spaced puddle clay stanks to prevent groundwater conveyance within the backfill. An alternative solution to avoid conveyance of the groundwater within the backfill is if the backfill is well-compacted to prevent voids that would convey groundwater.
- 6.8.4 All jointing bays along the cable route will be protected from groundwater ingress. A reinforced concrete slab will support the joint units with drainage sumps either end and backfilled with sand or gravel during construction phase. The joint units are resilient to flooding and typically need access every 4-5 years for inspection. The jointing bays will follow the same drainage strategy as the underground cables. At cable joint bays, sumps are provided to soak any water that may fall into them or groundwater that could enter on them during construction. Upon construction, joint bays are backfilled, so no standing water is assumed to remain within them. Thus, it is considered the cables have sufficient protection against flooding.
- 6.8.5 Subject to this mitigation, installation of the cables is not expected to increase flood risk or cause any localised raising of the groundwater levels.

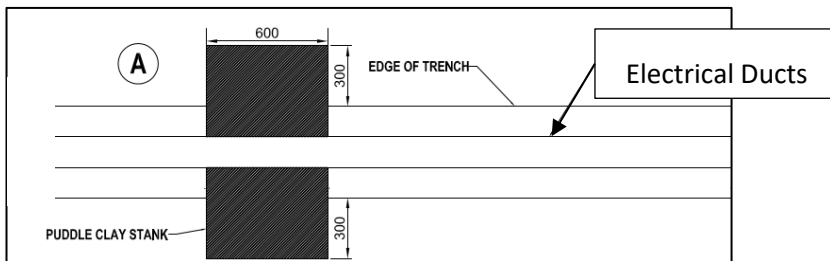

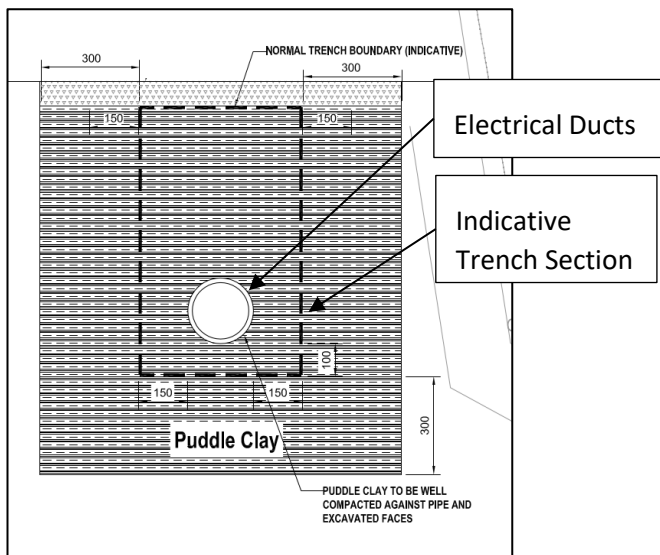

**Plate 6.10 Spaced puddle clay stanks along the cable route in the areas prone to groundwater risk**

## Substation and Converter Station

- 6.8.6 The proposed substation and converter station subbase level will be higher than the levels at which groundwater will be encountered. The compound levels have been raised to a level where the HVDC cable basements are above groundwater levels. The proposed platforms are formed with capping material above the existing ground. The typical construction pavement is 75mm thickness chippings, 300mm thickness Type 3 and 725mm thickness capping material.
- 6.8.7 All National Grid substations should be designed to provide resilience to a level equivalent to the 1:1000-year annual risk of flooding plus allowance for climate change.

## Attenuation Basins

- 6.8.8 The bases of all proposed attenuation basins are generally expected to be above groundwater levels. Where groundwater is elevated, lining of the basins with an impermeable geotextile or natural liner may be necessary to mitigate groundwater ingress, and anchoring of the liner may be required to manage buoyancy. The liner should be anchored to prevent uplift and the maximum basin depths will be limited to 0.5-1m deep and 0.3m freeboard.

# 7. Foul Water Drainage

- 7.1.1 The strategy of the foul water drainage design is established for two scenarios:
- Temporary foul drainage for the construction compounds.
  - Permanent foul drainage for the permanent features (substation and converter station).

## 7.2 Temporary Foul Water

- 7.2.1 Construction compounds will include portacabins for the staff as part of the onsite welfare facilities. The proposed construction compound layout is included in **2.13 Design and Layout Plans [APP-037]**.
- 7.2.2 It is proposed that there will be an independently managed foul drainage system within the construction compounds to contain waste produced from welfare and toilet facilities. It is expected that the foul water will be contained on site and regularly pumped, emptied, and transported off site. Therefore, there is no requirement for any formal piped foul drainage on site or any offsite connection.

## 7.3 Permanent Foul Water

- 7.3.1 Permanent foul water drainage is proposed for the operational use of the Friston substation and Saxmundham converter station. The proposed Converter Station and Substation Layouts are included in **2.13 Design and Layout Plans [APP-037]**.
- 7.3.2 The converter station and substation will contain a single storey service building with onsite welfare facilities for staff. However, no internal layouts have been developed at the current stage of the design. Consequently, foul water drainage has not been shown on scheme drawings.
- 7.3.3 TS 2.10.09 states that foul water shall connect into the public sewage system wherever possible, otherwise suitable sized sewage treatment system should be provided with a float switch and high-level alarm.
- 7.3.4 The cable route crosses sewers under Anglian Water ownership and interfaces with Anglian Water Assets (reference SEAL-MMD-SEAL-ENG-TCN-0121). There are Anglian Water public foul sewers in the vicinity of the proposed Saxmundham converter station, approximately 910m from the converter station along the new access road. The information related to the depth and condition of the sewers is unknown at the stage of this report. However, at this stage it is likely that a septic tank or treatment plant will be utilised on site, due to the long length of the connection.
- 7.3.5 However, there are no public foul sewers in the vicinity of the new Friston substation. The Manor Farm cottage is 600m east of the new substation, and it is not served by Anglian Water sewers. The closest Anglian Water sewers are in the town Knodishall located 1.6km to the east. It is proposed that the new substation will be served by an independent sewer treatment plant or septic tank. Septic tanks have a two or three chamber system that retains sewage for a sufficient time to allow the solids to form into a sludge at the base of the tank, where it is partially treated. The remaining effluent

drains from the tank by means of an outlet pipe direct to ground via a soakaway. A septic tank would need to be regularly de-sludge and serviced, the interval depending on the size of the tank and the number of personnel it serves. The installation of septic tanks is often not permitted in groundwater protection zones.

## 8. Water Quality

- 8.1.1 This Drainage Strategy is required to demonstrate that the scheme will not cause unacceptable deterioration to water quality and improves the water quality via a sustainable drainage system.
- 8.1.2 The contractor usually applies for applicable licences after detailed design, in accordance with the projects Drainage Management Plans will be produced post consent and must be substantially in accordance with the Drainage Strategies as secured under Requirement 6 within the Development Consent Order. The Drainage Management Plans will include a construction phase element and an operational phase element that may be discharged separately.
- 8.1.3 The temporary and permanent drainage systems on site will be designed to meet the water quality design criteria and good practice pollution control measures as outlined in the CIRIA SuDS Manual. Water quality management is to be finalised when construction compound layouts are confirmed as this will allow any high-risk areas to be identified and managed. The different areas of the site will be categorised by the appropriate pollution hazard level from Table 26.2 of The SuDS Manual.
- 8.1.4 At this stage proprietary treatment has not been shown on the drawings.

### Water and Sediment Quality During Construction Phase

- 8.1.5 CIRIA C648 Control of water pollution from linear construction sites has been consulted. This document provides guidance for constructors and designers to minimise the water pollution before and during construction stage.
- 8.1.6 Surface water and groundwater are highly vulnerable to pollution and impact from construction activities. The proposed Suffolk cable route sits within the catchment area of SPZs as indicated in the Section 5.4 of this report, but it does not affect any SPZ Zone I or II.
- 8.1.7 The following construction activities require specific mitigations for water pollution:
- Uncontrolled sediment erosion and contaminated silty runoff.
  - Refuelling facilities and handling areas.
  - Polluted drainage from the site.
  - Works within water.
- 8.1.8 Mitigations are not limited to these activities, and it should be noted that the contractor is responsible for managing risk of water pollution from all activities during the construction phase.
- The mitigation measures that will be taken to avoid water pollution:
  - Use prefabricated concrete products for outfalls and bridge piers.
  - Bridges extended to locate piers inland rather than adjacent to a watercourse.
  - Use stone gabions for bank reinforcement.

- Design shallow slopes in cutting /embankments to slow down the runoff, increase the infiltration and trap sediment.
- Establishing riparian buffers to protect watercourses and implement silt fences.
- Filtration (silt traps in the form of hay bales) units to intercept silt-laden water from the site to be discharged into the ditch.
- Sediment filter logs: A temporary sediment barrier of excelsior or coconut fibre used to intercept sediment runoff and help stabilize slopes. Protects storm drains, runoff ditches, brooks, streams, rivers, lakes and riparian banks.
- Using erosion control blankets in embankments to reduce concentrated flows, which also protects existing ditches and swales from new discharge flows.
- When directional drilling is the construction method selected for a watercourse crossing, special consideration should be given to the protection of ground water.
- Sealed manholes to be used in the design of construction drainage civils to reduce the risk of contaminated water spillage in the event that contaminated water enters the drainage system from the construction elements (construction compound or haul road) if the system becomes surcharged.
- When discharging water from a dewatering system (clean water from excavations), where there is likely to be potential for silt; water should be discharged to a settlement basin or similar before discharging into a watercourse.

8.1.9 Management plans will be set out for the contractor to manage environmental risks associated with the construction phase:

- **7.5.3 Outline Onshore Construction Environmental Management Plan [APP-340] (CEMP)**
- A Drainage Management Plan shall be prepared by the contractor which describes the approach to surface water and foul water drainage, and water supply during construction phase.
- A Flood Management Plan for the construction phase.
- Construction Method Statements for Protection of Onshore Water

8.1.10 Trenchless techniques used should have an appropriate method statement. This will be prepared post-consent and prior to the undertaking of the relevant works.

## Discharging Water into a River

8.1.11 To avoid existing waterbodies becoming contaminated by suspended sediments, the velocity of flows at the outfall should be reduced using baffles, blocks in the outfall apron or an energy-dissipater. The same consideration should be taken when over-pumping water along a watercourse.

8.1.12 Penstock or similar valves will be installed to automatically close or isolate the outfall in the event of a pollution incident. A monitoring and valve chamber will include a monitoring system designed to detect the pollutants posing a risk. The level of concentration of these pollutants can be set to within the sites allowable discharge limits and when exceeded, automatically close off the drainage route. The operation of the penstock or similar valve system will have a manual override in the case of a failure in

the automation system and all aspects of the system will be subject to routine inspection in line with the manufacturers recommendations.



## Plate 8.1 Outfalls with bank protection for discharge outfall and baffles on discharge hoses for temporary works

Source: CIRIA C648.

### Water Quality in Construction Compounds

8.1.13 Several construction compounds are proposed along the cable route. Early planning for the storage of potentially polluting materials, for supply and disposal of water, and for controlling runoff will reduce the risks of water pollution on site. The following has been considered in the proposed development:

- Locating the compound away from watercourses (including ditches) and aquifers.
- Avoiding locations that are designated conservation areas.
- Identifying areas with permitted access by public main road (reducing the need for haul roads).
- Considering the above points as priority, then identifying locations that already have services in place (e.g., hardstanding, water supply, power and connection to foul drainage systems).

8.1.14 The construction compounds will require the following:

- Agreements obtained for wastewater disposal.
- Locations selected for cesspits or package plants where no foul connection is available.
- Suitable refuelling area(s) selected on hardstanding with drainage via oil interceptor. The plant refuelling areas will have a concrete bund and runoff will run through an oil separator before entering the dirty filter drains or swales.
- Provision of adequate measures to control runoff from compounds and haul roads.
- Provision of a suitable vehicle wash area on hardstanding which drains to foul or shall be suitably treated on site.

- 8.1.15 To minimise the pollution in the construction compounds the following mitigations have been considered:
- The construction compound surfacing will utilise permeable materials where appropriate. Consideration should be given to the prevention of clogging of the permeable pavement by sediments. Permeable paving is particularly effective at removing the main pollutants: suspended solids, hydrocarbons, and metals.
  - An area for settlement of silts is to be included within the attenuation basins as the treatment method for sediment control. All settlement basins will be provided with oil absorbents to absorb any hydrocarbons accumulated.
  - Runoff from adjacent ground will be intercepted and prevented from entering the site, as this creates additional polluted runoff.
- 8.1.16 Compounds are to implement water conservation measures where appropriate:
- Water from settlement basins can be pumped into a bowser and used to damp down haul roads and site compounds to prevent the generation of dust.
  - Vehicle washing should only be used in a bunded area where the runoff can be contained and channelled to a treatment area, such as a settlement basin, prior to discharge. Runoff from washes and vehicle wash bays must not be allowed to enter surface water or foul water drainage systems without permission.
  - Storage areas should sit away from sensitive receptors, at least 10m from a watercourse or a land drain.

## **Water Quality in Haul Roads and Site Access**

- 8.1.17 To minimise pollution from the haul roads the following mitigations are proposed:
- 8.1.18 Haul road stabilisation reduces on-site erosion, reducing the sediment that may pollute nearby streams or be transported off site. There is potential for geogrid layers or other type of soil additives to be used for stabilisation. To minimise environmental impact, the following should be considered:
- Control of run off: After addition of binders – ensure fully mixed, fully compacted and curing protection applied.
  - Dust control to avoid contamination of nearby watercourses.
  - Haul road surfacing could be constructed using permeable materials where no groundwater is encountered, but consideration should be given to clogging of the permeable pavement by sediments which is very likely on a construction site. Permeable paving is particularly effective at removing the main pollutants: suspended solids, hydrocarbons and metals.
  - Ditches/swales should be constructed on either side, or on the downslope side, of haul roads to channel water to a treatment area (settlement basin).
  - Check dams and sediment traps across swales or drainage ditches to reduce the runoff velocity and promote the sedimentation. Swales can remove hydrocarbons.
  - Haul road crossing a stream: Straw bales should be positioned at either end of the culvert to prevent suspended solids moving along the watercourse.

- Where an existing bridge structure is used for a haul road, mud and debris should not be allowed to build up. Straw bales or sandbags should be placed along the edge of the existing bridge to prevent silty water running off into the water below.

## Water Quality During Operational Phase

- 8.1.19 The proposed surface water drainage system will improve the water quality of surface water runoff from the scheme, which ultimately outfalls to existing watercourses. This will be done by using a treatment chain where each subsequent system within the proposed drainage network provides treatment to improve water quality.
- 8.1.20 The proposed surface water treatment method will depend on the potential hazards on the site and the sensitivity of the receiving water body to pollution.
- 8.1.21 All transformer bunds will drain into oil water separator tanks that discharge into the platforms underground drainage system. In line with National Grid Standard TS 2.10.01, all transformers will have a totally sealed bund with a sump, which has a water control unit to pump water out. This will be directed through an oil separator to pick up any potential small levels of residual oil before being discharged into the main operational platform drainage system.
- 8.1.22 Access roads will drain into a filter drain system or the permeable platform, which will provide an adequate level of water quality treatment.

## 8.2 Consents

- 8.2.1 Licenses and consents required from drainage stakeholders in addition to the DCO should be applied for and granted before construction activities start. Early engagement with drainage stakeholders is discussed in Appendix D.
- 8.2.2 These consents establish the requirements for the following activities:
- discharging sewage to a foul sewer
  - discharging water to surface water (waterbody or sewer) or groundwater
  - pumping water from surface water or groundwater
  - working in or near water
  - working in tidal waters

## Discharging Water to Foul Water

- 8.2.3 To discharge to a public foul sewer, permission from the statutory sewerage undertaker is required, if the discharge is non-sanitary this may require a trade effluent consent.

## Discharging Water to Surface Water (Waterbody or Sewer) or Groundwater

- 8.2.4 The discharge of any matter to surface or groundwater requires a written “discharge consent” issued under the Water Resources Act 1991 by the EA, LLFA or the sewerage undertaker. If water is being abstracted prior to discharge (e.g., from an excavation or through dewatering to lower the water table), a transfer licence may be required. These

consents include agreement of the type of treatment prior to discharge, volume and rate of discharge, nature of the discharge (from groundwater or surface water).

### Abstracting and Dewatering

- 8.2.5 For dewatering or pumping out of water that has collected in an excavation or shaft, an abstraction licence is not required. However, a discharge consent may be required from the EA to dispose of or transfer the dewatered water.
- 8.2.6 Before any dewatering to lower the water table takes place, the environmental regulator must be consulted so it can issue appropriate authorisation.
- 8.2.7 Where water is proposed to be discharged into a watercourse or drainage ditch within an internal drainage district, consent for discharge is required from the Internal Drainage Board (IDB) under the Land Drainage Act 1991 and its associated Byelaws.

### Working in or Near Water

- 8.2.8 A consent is applied for and granted by the relevant water authority/regulator for the following activities:
- works in, over or under any main river,
  - works in, over or under all other watercourses (ordinary watercourses) if the flow is likely to be affected,
  - temporary works affecting the channel of main rivers or ordinary watercourses,
  - temporary and permanent works in the floodplain of main rivers.
- 8.2.9 Works within 7–10 m from the top of a main river or IDB watercourse bank may also require consent. Consultation should be undertaken with the EA/IDB to determine whether consent is needed. “Works” include temporary works such as a haul road, culvert diversion or stream diversion, as well as permanent works such as a new road bridge.
- 8.2.10 There should be no storage of spoil directly on watercourse banks. Where possible, spoil will be set back from watercourses by 10m. For main rivers, this is increased to 15m as secured by mitigation W02 of **7.5.3.2 CEMP Appendix B Register of Environmental Actions and Commitments (REAC) [APP-342]**. This will prevent excessive loading on the watercourse banks and minimise the risk of stored material entering the watercourses.

### Working in Tidal Water

- 8.2.11 Construction licences are required for the placement of materials in the tidal zone below mean high water springs (MHWS), which includes the tidal waters of any estuary, creek, bay or river, under the Food and Environment Protection Act 1985 (FEPA).
- 8.2.12 The design and operation of the development in the floodplain is not likely to increase the potential for flooding or create a risk of flood damage. Mitigation W12 within **7.5.3.2 CEMP Appendix B Register of Environmental Actions and Commitments (REAC) [APP-342]** sets out how this will be demonstrated.

# 9. Amenity

- 9.1.1 Standard 5 of the national standards for SuDS states that “A SuDS approach shall be adopted that maximises benefits for amenity through the creation of multi-functional places and landscapes”
- 9.1.2 To achieve this, the design of SuDS components seek to enhance the provision of high quality, attractive public space which can help provide health and wellbeing benefits, improve liveability for local communities and contribute to improving the climate resilience of new developments.
- 9.1.3 The guidance within Standard 5 explains how SuDS can add amenity value by contributing towards:
- making a multifunctional space, positively contributing to placemaking and environmental enhancement;
  - taking influence from the landscape character to ensure public acceptability and maximising amenity benefits;
  - reducing hazards from climate change;
  - promoting the safety and well-being of site users; and
  - educating the public on the benefits and function of proposed SuDS components
- 9.1.4 The drainage designs seek to make multifunctional use of the civil drainage infrastructure, by making many of the attenuation open-air in the form of basins, which add environmental enhancements to the scheme. It should be noted that the sites of the scheme are not public amenity spaces.
- 9.1.5 Whilst the sites of the scheme are not public amenity space, the drainage designs are intended to reflect the landscape character, by avoiding unnecessary earthworks and infrastructure wherever necessary.
- 9.1.6 As the drainage design accommodates a climate change uplift to rainfall, it inherently seeks to reduce the hazards of climate change.
- 9.1.7 Adjacent to access roads, filter drains are proposed wherever possible to facilitate a safe working environment, as open ditches would increase the risks to construction traffic.
- 9.1.8 The proposed Friston substation cuts off the route of an existing public right of way (PRoW) E-354/006/0 as seen in DCO document **7.5.9.1 Outline Public Rights of Way Management Plan [APP-352]**. Therefore, there is an opportunity to reroute the footpath via the proposed attenuation basins, providing public access around the basin, creating a multi-functional place that contributes positively to local public amenity.

# 10. Biodiversity

- 10.1.1 Standard 6 of the National Standards for SuDS states that “A SuDS approach shall be adopted to ensure the surface water drainage system maximises biodiversity benefits throughout the development lifecycle”
- 10.1.2 The proposed surface water drainage design shall add biodiversity value by:
- Creating diverse, self-sustaining, resilient local ecosystems which contribute to net gains in biodiversity
  - Supporting and promoting natural local habitat and species
  - Contributing to the delivery of local biodiversity strategies
  - Contributing to habitat connectivity
- 10.1.3 **6.2.2.2 Part 2 Suffolk Chapter 2 Ecology and Biodiversity [APP-049]** as part of the Environmental Statement (ES) identifies scale and ecological sensitivity of the sites and potential areas of habitat loss. Proposed SuDS for the development assist in mitigating biodiversity impacts of the development and support improvements to biodiversity.
- 10.1.4 While the ES states that there are habitat losses due to the development, these are not permanent losses. This is because there would be extensive habitat creation as part of the proposed project, around the Friston Substation, along the permanent access road where hedgerows would be planted and around the permanent crossing of the River Fromus.
- 10.1.5 As a result, there would be a long-term increase in woody and wetland habitats due to the Suffolk Onshore Scheme, increasing the ecological value of what is currently a predominantly arable landscape of relatively low diversity of habitat structure.
- 10.1.6 An example of habitat creation as stated in the ES is the attenuation/infiltration basins around the Saxmundham Converter Station and Friston Substation, and in various locations including along the River Fromus. As a result of the basins, there would be a long-term increase in wetland habitats. The ES states that following the construction of the Saxmundham Converter Station and Friston Substation there would be an overall increase in wetland perimeter of approximately 500m due to the permanent attenuation and infiltration basins. Refer to the ES for more detail on the potential benefits and impacts on ecology and biodiversity of the Suffolk Onshore Scheme.

# 11. Design of Drainage for Construction, Operation, Maintenance, decommissioning and Structural Integrity

11.1.1 Standard 7 of the National SuDS Standards requires that:

- All elements of the surface water drainage system should be designed so that they can be constructed easily, safely, cost-effectively, in a timely manner, and minimising negative impacts on the environment;
- All elements of the surface water drainage system should be designed so that maintenance and operation can be undertaken easily, safely, cost-effectively, in a timely manner, and minimising embedded carbon; and
- The surface water drainage system should be designed to ensure structural integrity of all elements over the design life.
- The surface water drainage system will be designed and detailed in accordance with current best practice and guidance to meet this standard.

## 11.2 Maintenance

11.2.1 The Applicant will be responsible for maintaining the SuDS within the development. Section 32.4 of the SuDS Manual categorises maintenance work as follows:

- Regular maintenance – includes basic tasks which should be carried out to a frequent and predictable schedule.
- Occasional maintenance – includes tasks that are likely to be required on a regular basis but at a less frequent rate compared to regular maintenance.
- Remedial maintenance – includes tasks that may be required to rectify faults associated with the system. Although the amount of remedial maintenance can be reduced via good design and construction, unforeseen issues can occur. Remedial maintenance may be required due to site specific characteristic or unforeseen events.

11.2.2 As part of the design of the SuDS, a SuDS Asset Maintenance Plan will need to be developed that sets out the regime for their maintenance and a schedule for each of the maintenance tasks. An example of maintenance for the proposed SuDS is seen in Table 11.1 below.

**Table 11.1 SuDS maintenance plan**

<b>SuDS Type</b>	<b>Maintenance Type</b>	<b>Description</b>
Attenuation Basins	Routine/ Regular Maintenance	Remove litter and debris Cut grass Inspect inlets, outlets and overflow blockages and clear if required Check any penstocks and other mechanical devices
	Occasional Maintenance	Remove sediment when required
	Remedial Maintenance	Repair/rehabilitate inlets, outlets and overflows
Filter Drains	Routine/ Regular Maintenance	Mow grassed edge surrounding the drain monthly or as required.
	Occasional Maintenance	Hand pull weed growth in filter drain as required, ensuring no weed killer enters the filter drain.
	Remedial Maintenance	When there is silt at the surface of the filter drain, remove and replace the surface stone layer. Additionally, replace and remove the perforated HDPE pipe as required.
Swales	Routine/ Regular Maintenance	Mow swale grass to 100mm with 150mm max to filter and control runoff, remove cutoffs to wildlife piles on site monthly or as required.  Where wetland develops in the swale due to wet conditions, cut annually or as required.
	Occasional Maintenance	When there is a build-up of silts above the swale design level, remove and spread on site as required.
	Remedial Maintenance	Any damage to swales to be repaired to design profile as required.

## 11.3 Decommissioning

- 11.3.1 Permanent scheme drainage assets such as land drainage diversions and surface water networks shall be decommissioned or replaced at the end of their design life.

- 11.3.2 Haul roads constructed to deliver the scheme are temporary assets and will therefore be removed at the end of the construction period. This will include the removal of relevant cross drains and filter drains.
- 11.3.3 Attenuation basins are also temporary assets where they serve only the construction compounds and temporary haul roads. These are to be removed following completion of works, and the land reinstated to its previous use.

## 11.4 Structural Integrity

- 11.4.1 All materials and components used within the surface water drainage system shall be suitable to resist all imposed design loadings with appropriate factors of safety and shall have equivalent design life to the proposed development or have a replacement plan accounted for in the maintenance plan.
- 11.4.2 A separation distance of 1.2m is specified between the crown of the pipes to the FFL to protect piping below, as per the Sewerage Sector Guidance – Appendix C - Design and Construction Guidance<sup>13</sup>. If this separation distance cannot be achieved, concrete pipe surrounds shall be proposed.
- 11.4.3 When proposed infiltration basins/systems are within 5m of any existing or proposed buildings roads embankments or other infrastructure, risk shall be assessed and measures applied if required. Infiltration systems in ground which may be unstable may need to be an additional 5m away from the existing or proposed infrastructure.

---

<sup>13</sup> [Sewerage Sector Guidance - approved documents | Water UK](#)

# 12. Conclusions

## 12.1 Assumptions and Risks

- 12.1.1 Appendix A includes assumptions, risks and opportunities for basins and their contributing catchment areas.
- 12.1.2 As typical in outline design, some assumptions have been considered to produce this drainage strategy for the proposed Suffolk Sea Link cable route. The main assumptions are discussed below:
- The proposed discharge rate for all proposed attenuation has been restricted based on the estimated 'greenfield' run-off rate ( $Q_{bar}$ ) for the undeveloped site, A minimum advisable of 2l/s has been applied where  $Q_{bar}$  is calculated to be <2l/s as per guidance from HR Wallingford Greenfield runoff rate estimation tool.
  - Contributing catchment areas has been calculated based on the contributing areas defined on the proposed layout of each element described below:
    - Haul Roads: 100% impermeable within their gross site areas
    - Permanent Access Roads: 100% impermeable within their gross site areas
    - Construction compounds: 70% impermeable within their gross site areas
    - HVAC construction swathe: 20% impermeable within their gross site areas
    - HVDC construction swathe: 25% impermeable within their gross site areas
    - Friston Substation: 60% impermeable within their gross site areas
    - Saxmundham Converter station: 60% impermeable within their gross site areas.
  - All outfalls identified during the production of this report are based on the latest topographical survey carried out by 3D engineering in November 2023. When topographical survey is not available, LIDAR or OSTerrain5 is used to identify the minimum elevation of the outfalls.
  - The proposed locations for the attenuation and infiltration basins are based on existing ground level and a gravity system (i.e. following the fall of the land) towards the watercourse where the attenuation basins discharge. The watercourse topography will dictate the outfall elevation and consequently, the location of the proposed basins. Where no data on the watercourse is available, recommendations for surveying the watercourses and then defining the elevation of the outfall are included in Appendix A for each contributing catchment area and basin.
  - The proposed attenuation volumes do not include attenuation within the filter drains or swales. Consequently, the attenuation/infiltration volumes of the basins will be refined at later design stages and there may be opportunity to reduce these volumes by utilising attenuation volume available in the upstream drainage features.
  - It is proposed that a new ditch runs along the perimeter of the proposed platforms and construction swathe to absorb overland flows. It is assumed there will be a suitable discharge connection into the closest watercourse from these land drains. If

no suitable route can be identified to discharge by gravity into a watercourse, pumping could be required and possibly attenuation.

## 12.2 Opportunities

- 12.2.1 All attenuation and infiltration basins should have a minimum clearance from overhead columns as defined by the Overhead Electrical Engineer. At the current stage of the project the specific clearance requirements for each existing column has not been defined. Each column could have a different clearance, and this will be stated in a subsequent stage of the project. The current design conservatively assumes all basins to have a clearance of 15m from any existing column, providing the biggest land take. This assumption could be reviewed at later design stages.

# Appendix A Preliminary Drainage Design Summary

## Appendix A: Drainage Design Summary

- Storage volumes within upstream pipework, filter drains, etc, have been excluded from pond storage calculations.
- Volumetric Runoff Coefficient, Cv values for summer and winter set to 1.
- Where a proposed attenuation pond is used for temporary sediment control during construction, a settling pond or vegetated forebay within the main pond should be included to trap sediments. Sediment trap should be approximately 20% of the pool volume. This extra volume is being excluded from the attenuation volume calculations.
- The Lower/Higher factor of confidence is defined based on the background information available at the time of drafting this report. Where any design value is assumed, a Low Confidence is given to the design.
- All outfall levels are revised as per new topographical survey data. (Topographical survey by 3D Engineering Surveys Limited dated October 2023).
- The method to produce the drainage calculations has used the following input data:
  - The proposed catchment areas have been extracted from the scheme plans and assigned the appropriate design criteria (for temporary and permanent design).
  - The discharge rates have been associated to each catchment area according to the impermeable area of each catchment following the criteria for the post-development discharge rate Qbar.
- Catchment descriptors have been imported from the UK Centre for Ecology and Hydrology (CEH) Flood Estimation Handbook (FEH) for three catchments, see Appendix C. This FEH data has been used to obtain the greenfield runoff rates in accordance with SCC Local SUDS Guidance dated March 2023. FEH Catchment descriptors used are listed below:
  - FEH\_Catchment\_Descriptors\_646850\_258300 (East and Northeast)
  - FEH\_Catchment\_Descriptors\_643050\_257850 (South of the site)
  - FEH\_Catchment\_Descriptors\_638850\_261350 (West of the site)
- Point descriptors for runoff rate estimation have been imported from the UK Centre for Ecology and Hydrology (CEH) Flood Estimation Handbook (FEH) in three locations to provide representative rainfall prediction throughout the scheme, see Appendix J. FEH data is used to estimate the rainfall depths and volumes in accordance with the requirements of National Grid guidance TS 2.10.09 and SCC Local SUDS Guidance dated March 2023. FEH point rainfall used for the rainfall is listed below:
  - FEH point rainfall 646965-259182 (For temporary ponds)
  - FEH point rainfall 641430-261465 (For permanent ponds near the substation)
  - FEH point rainfall 639361-262567 (For permanent ponds west of the cable route)
- Pond Reference name:
  - TC: Temporary Catchment
  - PC: Permanent Catchment
  - INPN: Infiltration Pond
  - ATPN: Attenuation Pond

POND REFERENCE	CONTRIBUTING CATCHMENT AREA (HA)	MINIMUM ATTENUATION VOLUME (M <sup>3</sup> )	OUTFALL DETAILS				
			DISCHARGE RATE (L/S)	OWNER	CONSENTING BODY	CONFIDENCE	NOTES/ASSUMPTIONS/RISKS
Temporary TC-20-INPN	3.43 (HDD Construction Compound, HVDC cable swathe)	994.60	Full Infiltration $1 \times 10^{-5}$ is assumed	Private	SCC	Low	<p><b>Notes:</b> SSL carried out a Ground Investigation (GI) at trial pit F22-TP222A in December 2023, but no soakaway testing was taken in this TP. However, the description of superficial deposits (Orangish brown gravelly slightly silty fine to coarse SAND. Gravel is angular to subrounded fine to medium flint and quartzite) indicates that infiltration could be possible. Hence, an infiltration rate of <math>1 \times 10^{-5}</math> is assumed. A trial pit F22-TP222A presented no groundwater (TP 4m deep). FEH point rainfall 646965-259182 is used for this area. FEH_Catchment_Descriptors_646850_258300 is used for this area.</p> <p><b>Risks:</b> If infiltration is found to be infeasible, then an attenuation-only pond could be required. If no watercourse encountered where to discharge the pond flows, then temporary pumping system to a portable tank could be required by the contractor.</p> <p><b>Next step:</b> On detail design, soakaway in accordance with recommended practice given in BRE Digest 365 to be carry out at pond location.</p>
Temporary TC-21-INPN	2.14 (Cable swathe HVDC)	147.80	Full Infiltration measured to be $2.34 \times 10^{-4}$ m/s	Aldeburgh Golf Club	SCC	High	<p><b>Notes:</b> SSL carried out ground investigation at close proximity (F22-TP221 and F22-TP513A) to the proposed pond location in December 2023, the infiltration at TP5123A is measured to be <math>2.34 \times 10^{-4}</math> m/s. No groundwater is encountered at a depth of 1.2m in close approximately to the proposed pond location. FEH point rainfall 646965-259182 is used for this area. FEH_Catchment_Descriptors_646850_258300 is used for this area.</p> <p><b>Opportunities:</b> Infiltration pond could provide clean water for Aldeburgh Golf Course to reuse for their site.</p>

POND REFERENCE	CONTRIBUTING CATCHMENT AREA (HA)	MINIMUM ATTENUATION VOLUME (M <sup>3</sup> )	OUTFALL DETAILS				
			DISCHARGE RATE (L/S)	OWNER	CONSENTING BODY	CONFIDENCE	NOTES/ASSUMPTIONS/RISKS
Temporary TC-22-INPN	2.12 (cable swathe HVDC)	147.80	Full Infiltration 2.34 × 10 <sup>(-4)</sup> m/s is assumed	Private	SCC	Low	<p><b>Notes:</b></p> <p>SSL carried out ground investigation at F22-TP220. Superficial deposits are described as Orangish brown gravelly silty fine to medium SAND. Gravel angular to rounded fine to coarse flint and mudstone.(LOWESTOFT FORMATION) from 1.40m they are becoming very gravelly SAND.</p> <p>No soakaway test was undertaken at TP220, but the superficial deposits were very similar to the superficial deposits encountered at TP5123A, which is 200m from TP220, so a infiltration rate of 2.34 × 10<sup>(-4)</sup> m/s is proposed.</p> <p>No groundwater is encountered at a depth of 4m (depth of F22-TP220).</p> <p>FEH point rainfall 646965-259182 is used for this area.</p> <p>FEH_Catchment_Descriptors_646850_258300 is used for this area.</p> <p><b>Risks</b></p> <p>If infiltration is found to be infeasible, then an attenuation-only pond could be required and/or the pond may need to be relocated. If no watercourse encountered where to discharge the pond flows, then temporary pumping system to a portable tank could be required by the contractor.</p> <p><b>Next step:</b></p> <p>On detail design, soakaway in accordance with recommended practice given in BRE Digest 365 to be carry out at pond location.</p> <p><b>Opportunities:</b></p> <p>Infiltration pond could provide clean water for Aldeburgh Golf Course to reuse for their site.</p>

POND REFERENCE	CONTRIBUTING CATCHMENT AREA (HA)	MINIMUM ATTENUATION VOLUME (M <sup>3</sup> )	OUTFALL DETAILS				
			DISCHARGE RATE (L/S)	OWNER	CONSENTING BODY	CONFIDENCE	NOTES/ASSUMPTIONS/RISKS
Temporary TC-23-INPN	0.83 (cable swathe HVDC)	54.80	Full Infiltration $2.34 \times 10^{-4}$ m/s is assumed	Private	SCC	Low	<p><b>Notes:</b>                      SSL did not carry out ground investigation at the site.                      From BGS superficial deposit mapping, the superficial deposits shown at this location are similar to the superficial deposits from TP5123A; therefore an assumed discharge rate of <math>2.34 \times 10^{-4}</math> m/s is considered.                      Unknown groundwater.                      FEH point rainfall 646965-259182 is used for this area.                      FEH_Catchment_Descriptors_646850_258300 is used for this area.</p> <p><b>Risks</b>                      If infiltration is found to be infeasible, then an attenuation-only pond could be required and/or the pond may need to be relocated. If no watercourse encountered where to discharge the pond flows, then temporary pumping system to a portable tank could be required by the contractor.</p> <p><b>Next step:</b>                      On detail design, soakaway in accordance with recommended practice given in BRE Digest 365 to be carry out at pond location. Trial Pit to investigate the groundwater depth is required.</p> <p><b>Opportunities:</b>                      Possible water re-use for Chapel Barn Farm immediately north of the cable route.</p>

POND REFERENCE	CONTRIBUTING CATCHMENT AREA (HA)	MINIMUM ATTENUATION VOLUME (M <sup>3</sup> )	OUTFALL DETAILS				
			DISCHARGE RATE (L/S)	OWNER	CONSENTING BODY	CONFIDENCE	NOTES/ASSUMPTIONS/RISKS
Temporary TC-24-INPN	1.77 (cable swathe HVDC)	120.20	Full Infiltration $2.34 \times 10^{-4}$ m/s is assumed	Private	SCC	Low	<p><b>Notes:</b> SSL did not carry out ground investigation at the site. From BGS superficial deposit mapping, the superficial deposits shown at this location are similar to the superficial deposits from TP5123A; therefore, an assumed discharge rate of <math>2.34 \times 10^{-4}</math> m/s is considered. Unknown groundwater. FEH point rainfall 646965-259182 is used for this area. FEH_Catchment_Descriptors_646850_258300 is used for this area.</p> <p><b>Risks:</b> If infiltration is found to be infeasible, then an attenuation-only pond could be required and/or the pond may need to be relocated. If no watercourse encountered where to discharge the pond flows, then temporary pumping system to a portable tank could be required by the contractor.</p> <p><b>Next step:</b> On detail design, soakaway in accordance with recommended practice given in BRE Digest 365 to be carry out at pond location. Trial Pit to investigate the groundwater depth is required.</p> <p><b>Opportunities:</b> Possible water re-use for Chapel Barn Farm immediately north of the cable route.</p>
Temporary TC-25-INPN	3.61 (cable swathe HVDC)	291.80	Full Infiltration is measured to be $1.52 \times 10^{-4}$ m/s	Private	SCC	High	<p><b>Notes:</b> SSL carried out ground investigation at close proximity (TP404A) to the proposed pond location in December 2023, the infiltration is measured to be <math>1.52 \times 10^{-4}</math> m/s. No ground water is encountered at a depth of 4.2m (depth of TP404A). FEH point rainfall 646965-259182 is used for this area. FEH_Catchment_Descriptors_643050_257850.</p>

POND REFERENCE	CONTRIBUTING CATCHMENT AREA (HA)	MINIMUM ATTENUATION VOLUME (M <sup>3</sup> )	OUTFALL DETAILS				
			DISCHARGE RATE (L/S)	OWNER	CONSENTING BODY	CONFIDENCE	NOTES/ASSUMPTIONS/RISKS
Temporary TC-26-INPN	3.47 (Temporary Compound, cable swathe HVDC)	428.80	Full Infiltration is measured to be $1.52 \times 10^{-4}$ m/s	Private	SCC	High	<p><b>Notes:</b></p> <p>SSL carried out ground investigation at close proximity (TP404A) to the proposed pond location in December 2023, the infiltration is measured to be <math>1.52 \times 10^{-4}</math> m/s.</p> <p>No ground water is encountered at a depth of 4.2m (depth of TP404A). FEH point rainfall 646965-259182 is used for this area.</p> <p>FEH_Catchment_Descriptors_643050_257850.</p>
Temporary TC-28-ATPN	2.67 (HVDC cable swathe)	692.70	Rising Main to temporary infiltration pond TC-26-INPN Pump rate 2.35 l/s	Private	None	High	<p><b>Notes:</b></p> <p>SSL carried out ground investigation a close proximity (TP204) to the pond location in December 2023. It suggested no infiltration is possible.</p> <p>This pond discharges to the infiltration pond downstream with reference TC-26-INPN at 2.35 l/s flow rate via a temporary rising main. The pond TC-28-ATPN captures the runoff intercepted from a haul road within the catchment of a HVDC cable swathe. As this is a temporary condition is assumed acceptable.</p> <p>No groundwater is encountered at a depth of 4m at TP204, which is the trial pit at the proposed pond location.</p> <p>FEH point rainfall 646965-259182 is used for this area.</p> <p>FEH catchment descriptor 643050_257850 is used to calculate the discharge rate from this pond.</p> <p><b>Opportunities:</b></p> <p>Possible water re-use for Park Farm. Stakeholder engagement with landowner required.</p>

POND REFERENCE	CONTRIBUTING CATCHMENT AREA (HA)	MINIMUM ATTENUATION VOLUME (M <sup>3</sup> )	OUTFALL DETAILS				
			DISCHARGE RATE (L/S)	OWNER	CONSENTING BODY	CONFIDENCE	NOTES/ASSUMPTIONS/RISKS
TC-30-INPN	7.98 (Temporary Compound, HVDC cable swathe)	1953.50	Full Infiltration $1 \times 10^{-5}$ m/s is assumed	Private	SCC	Low	<p><b>Notes:</b> No SSL GI is available at this pond location. However, the description of superficial deposits (Lowestoft Formation - Sand and Gravel) indicates that infiltration could be possible. Hence, an infiltration rate of <math>1 \times 10^{-5}</math> is assumed.</p> <p>Unknown depth of groundwater. However, the lack of watercourses in the area and the nature of the superficial deposits indicate the risk of shallow groundwater encountered at the pond location is low. FEH point rainfall 646965-259182 is used for this area. FEH_Catchment_Descriptors_643050_257850.</p> <p><b>Risks:</b> Soakaway testing to be taken at next stage of the design. If infiltration is found to be infeasible, then an attenuation pond will be required and an outfall location would need to be identified towards Friston, resulting in further land take. If no watercourse encountered where to discharge the pond flows, then temporary pumping system to a portable tank could be required by the contractor.</p> <p><b>Next step:</b> On detail design, soakaway in accordance with recommended practice given in BRE Digest 365 to be carry out at pond location. Trial Pit to investigate the groundwater depth is required.</p>

POND REFERENCE	CONTRIBUTING CATCHMENT AREA (HA)	MINIMUM ATTENUATION VOLUME (M <sup>3</sup> )	OUTFALL DETAILS				
			DISCHARGE RATE (L/S)	OWNER	CONSENTING BODY	CONFIDENCE	NOTES/ASSUMPTIONS/RISKS
TC-31-ATPN	3.60 (HVDC cable swathe)	566.40	3.75	EA – Hundred River	EA	High	<p><b>Notes:</b></p> <p>Discharge to River Hundred, either via gravity drainage pipe or a possible existing ditch leading to the river.</p> <p>No SSL GI is available at this pond location. Discharge to River Hundred is proposed. Invert Level (IL) of the outfall is assumed based on adjacent topographical survey = +7.62mAOD.</p> <p>FEH catchment descriptor 646850_258300 is used to calculate the discharge rate from this pond.</p> <p>FEH point rainfall 646965-259182 is used for this area.</p> <p><b>Opportunities:</b></p> <p>Possible water re-use for Manor Farm Knodishall. Stakeholder engagement with landowner required.</p> <p><b>Next step:</b></p> <p>Topographical data of the proposed ditch at the outfall location is required.</p>

POND REFERENCE	CONTRIBUTING CATCHMENT AREA (HA)	MINIMUM ATTENUATION VOLUME (M <sup>3</sup> )	OUTFALL DETAILS				
			DISCHARGE RATE (L/S)	OWNER	CONSENTING BODY	CONFIDENCE	NOTES/ASSUMPTIONS/RISKS
TC-32-ATPN	0.99 (HVDC cable swathe)	133.10	2	Private	SCC	Low	<p><b>Notes:</b>  Discharge to nearest ditch, either via gravity drainage pipe.  Invert Level (IL) of the outfall is assumed based on adjacent topographical survey = +21.10mAOD.  FEH catchment descriptor 646850_258300 is used to calculate the discharge rate from this pond.  FEH point rainfall 646965-259182 is used for this area.</p> <p><b>Risks:</b>  If the existing ditch does not lead to a downstream network of watercourses, then the flows may need to be directed East towards the River Hundred; or the flows will be discharged into the downstream pond TP-31-ATPN.</p> <p><b>Opportunities:</b>  Possible water re-use for Manor Farm Knodishall. Stakeholder engagement with landowner required.</p> <p><b>Next step:</b>  Topographical data of the proposed ditch at the outfall location is required.</p>

POND REFERENCE	CONTRIBUTING CATCHMENT AREA (HA)	MINIMUM ATTENUATION VOLUME (M <sup>3</sup> )	OUTFALL DETAILS				
			DISCHARGE RATE (L/S)	OWNER	CONSENTING BODY	CONFIDENCE	NOTES/ASSUMPTIONS/RISKS
TC-33-ATPN	1.00 (HVDC cable swathe)	135.00	2	Private	SCC	Low	<p><b>Notes:</b>            Discharge to nearest watercourse/ditch, either via gravity drainage pipe. The ditch is a road ditch.            Invert Level (IL) of the outfall is assumed based on adjacent topographical survey = +23.00mAOD.            FEH catchment descriptor 643050_257850 is used to calculate the discharge rate from this pond.            FEH point rainfall 646965-259182 is used for this area.</p> <p><b>Risks:</b>            If the existing watercourse does not lead to a network at lower elevation, then the flows may need to be directed East towards the River Hundred; or the flows will be discharge into the downstream pond TP-31-ATPN.            There is an existing water main at the ditch location.            There is not topographical survey data of the ditch</p> <p><b>Next step:</b>            Topographical data of the proposed ditch at the outfall location is required.</p>

POND REFERENCE	CONTRIBUTING CATCHMENT AREA (HA)	MINIMUM ATTENUATION VOLUME (M <sup>3</sup> )	OUTFALL DETAILS				
			DISCHARGE RATE (L/S)	OWNER	CONSENTING BODY	CONFIDENCE	NOTES/ASSUMPTIONS/RISKS
TC-35-ATPN	1.12 (HVDC cable swatch)	154.20	2	Private	SCC	Low	<p><b>Notes:</b>            Discharge to nearest watercourse/ditch, either via gravity drainage pipe or a possible existing ditch leading to the river.            Invert Level (IL) of the outfall is assumed based on adjacent topographical survey = +16.10mAOD.            FEH catchment descriptor 643050_257850 is used to calculate the discharge rate from this pond.            FEH point rainfall 646965-259182 is used for this area</p> <p><b>Risks:</b>            If the existing watercourse does not lead to a network at lower elevation, then the flows may need to be directed 200m west towards the temporary attenuation pond TC-37-ATPN via a pumping discharge.            There is not topographical survey data of the ditch.</p> <p><b>Next step:</b>            Topographical data of the proposed ditch at the outfall location is required.</p>

POND REFERENCE	CONTRIBUTING CATCHMENT AREA (HA)	MINIMUM ATTENUATION VOLUME (M <sup>3</sup> )	OUTFALL DETAILS				
			DISCHARGE RATE (L/S)	OWNER	CONSENTING BODY	CONFIDENCE	NOTES/ASSUMPTIONS/RISKS
TC-36-INPN	6.48 (HVAC cable swathe, HVDC cable swathe, and two temporary compounds)	1679.10	Hybrid system infiltration rate of $4 \times 10^{-5} m/s$ measured and discharge rate of 5 l/sec	Private	SCC	High	<p><b>Notes:</b></p> <p>Ground investigation at this location was carried out as part of the SPR substation design.</p> <p>Infiltration rate was identified as <math>4 \times 10^{-5} m/s</math>.</p> <p>This pond is designed to allow for infiltration only</p> <p>FEH catchment descriptor 643050_257850 is used to calculate the discharge rate from this pond.</p> <p>FEH point rainfall 646965-259182 is used for this area.</p>

POND REFERENCE	CONTRIBUTING CATCHMENT AREA (HA)	MINIMUM ATTENUATION VOLUME (M <sup>3</sup> )	OUTFALL DETAILS				
			DISCHARGE RATE (L/S)	OWNER	CONSENTING BODY	CONFIDENCE	NOTES/ASSUMPTIONS/RISKS
TC-37-ATPN	2.37 (HVAC cable swathe)	209.30	2.14	Private	SCC	High	<p><b>Notes:</b></p> <p>It is acceptable for the watercourse identified for the proposed outfall location to receive water at three different discharge points along a ~600m stretch.</p> <p>FEH catchment descriptor 643050_257850 is used to calculate the discharge rate from this pond.</p> <p>FEH point rainfall 646965-259182 is used for this area.</p> <p>There is topographical survey data for the top of the embankment ditch and bottom of the ditch: top of the ditch is +18.81mAOD and bottom of the ditch is +17.75m AOD.</p> <p>Outfall Data: IL=18.00mAOD.</p> <p><b>Risks:</b></p> <p>If the watercourse does not have the capacity to accept 5l/s flow from the discharge points along a ~600m stretch, then outfalls may need to be combined and ponds may need to be larger.</p>
TC-39-ATPN	1.51 (HVAC cable swathe)	167.80	4.28	Private	SCC	Low	<p><b>Notes:</b></p> <p>Discharge to nearest watercourse, either via gravity drainage pipe.</p> <p>Invert Level (IL) of the outfall is assumed based on adjacent topographical survey = +21.25mAOD.</p> <p>FEH catchment descriptor 643050_257850 is used to calculate the discharge rate from this pond.</p> <p>FEH point rainfall 646965-259182 is used for this area.</p> <p><b>Next step:</b></p> <p>Topographical data of the proposed ditch at the outfall location is required.</p>

POND REFERENCE	CONTRIBUTING CATCHMENT AREA (HA)	MINIMUM ATTENUATION VOLUME (M <sup>3</sup> )	OUTFALL DETAILS				
			DISCHARGE RATE (L/S)	OWNER	CONSENTING BODY	CONFIDENCE	NOTES/ASSUMPTIONS/RISKS
TC-40-ATPN	1.97 (HVAC cable swathe)	178.10	5.35	Private	SCC	High	<p><b>Notes:</b>  Discharge to nearest watercourse, either via gravity drainage pipe.  There is topographical survey data for the top of the embankment ditch and bottom of the ditch: top of the ditch is +12.82mAOD and bottom of the ditch is +12.03m AOD.  Outfall data: IL=12.40mAOD.  FEH catchment descriptor 638850_261350 is used to calculate the discharge rate from this pond.  FEH point rainfall 646965-259182 is used for this area</p> <p><b>Opportunities:</b>  Possible water re-use at Moor Farm. Stakeholder engagement with landowner required.</p> <p><b>Risks:</b>  The proposed ditch is a receptor of two combined discharge rates ( TC-40-ATPN and TC-41-ATPN) with a combined discharge rate of 15l/s. It is assumed acceptable as it is a temporary discharge rate.  If the watercourse does not have the capacity to accept the combined discharge rate, then ponds may need to be larger.</p>

POND REFERENCE	CONTRIBUTING CATCHMENT AREA (HA)	MINIMUM ATTENUATION VOLUME (M <sup>3</sup> )	OUTFALL DETAILS				
			DISCHARGE RATE (L/S)	OWNER	CONSENTING BODY	CONFIDENCE	NOTES/ASSUMPTIONS/RISKS
TC-41-ATPN	5.15 (HVAC cable swathe, HVDC cable swathe)	498.20	12.20	Private	SCC	High	<p><b>Notes:</b></p> <p>Discharge to nearest watercourse, either via gravity drainage pipe. There is topographical survey data for the top of the embankment ditch and bottom of the ditch: top of the ditch is +12.82mAOD and bottom of the ditch is +12.03m AOD.</p> <p>Outfall data: IL=12.40mAOD.</p> <p>FEH catchment descriptor 638850_261350 is used to calculate the discharge rate from this pond.</p> <p>FEH point rainfall 646965-259182 is used for this area</p> <p><b>Risks:</b></p> <p>The proposed ditch is a receptor of two combined discharge rates ( TC-40-ATPN and TC-41-ATPN) with a combined discharge rate of 15l/s. It is assumed acceptable as it is a temporary discharge rate. If the watercourse does not have the capacity to accept the discharge points, then outfalls may need to be combined and ponds may need to be larger.</p>
TC-44-ATPN	8.24 (Temporary compound, HVDC cable swathe, Temporary haul road)	3738.50	18.30	Private	SCC	High	<p><b>Notes:</b></p> <p>Discharge to nearest watercourse, either via gravity drainage pipe or a possible existing ditch leading to the river.</p> <p>There is topographical survey data for the top of the embankment ditch and bottom of the ditch: top of the ditch is +17.52mAOD and bottom of the ditch is +16.41m AOD.</p> <p>Outfall data: IL=16.9mAOD.</p> <p>FEH catchment descriptor 638850 - 261350 is used to calculate the discharge rate from this pond.</p> <p>FEH point rainfall 646965-259182 is used for this area .</p>

POND REFERENCE	CONTRIBUTING CATCHMENT AREA (HA)	MINIMUM ATTENUATION VOLUME (M <sup>3</sup> )	OUTFALL DETAILS				
			DISCHARGE RATE (L/S)	OWNER	CONSENTING BODY	CONFIDENCE	NOTES/ASSUMPTIONS/RISKS
TC-45-ATPN	0.75 (Temporary compound for bridge installation)	326.00	2.35	Private	East Suffolk WMB	High	<p><b>Notes:</b></p> <p>Discharge to nearest watercourse, either via gravity drainage pipe or a possible existing ditch leading to the river.</p> <p>There is topographical survey data for the top of the embankment ditch and bottom of the ditch: top of the ditch is +9.40mAOD and bottom of the ditch is +7.42m AOD.</p> <p>Outfall data IL=7.70m.</p> <p>FEH catchment descriptor 638850_261350 is used to calculate the discharge rate from this pond.</p> <p>FEH point rainfall 646965-259182 is used for this area.</p>
PC-01-INPN	2.18 (Friston substation and its permanent access road)	652	Infiltration only	Private	SCC	High	<p><b>Notes:</b></p> <p>Ground investigation at this location was carried out as part of the SPR substation.</p> <p>Infiltration rate was identified as <math>4 \times 10^{-5} m/s</math>.</p> <p>This pond is designed to allow for infiltration</p> <p>FEH point rainfall 641430-261465 is used for this area.</p>

POND REFERENCE	CONTRIBUTING CATCHMENT AREA (HA)	MINIMUM ATTENUATION VOLUME (M <sup>3</sup> )	OUTFALL DETAILS				
			DISCHARGE RATE (L/S)	OWNER	CONSENTING BODY	CONFIDENCE	NOTES/ASSUMPTIONS/RISKS
PC-02-ATPN	0.57 (Permanent road to Friston substation)	724.40	2	Private	SCC	Lower	<p><b>Notes:</b>  Discharge to nearest watercourse, either via gravity drainage pipe or a possible existing ditch leading to the river.  Invert Level (IL) of the outfall is assumed based on adjacent topographical survey = +17.40mAOD.  FEH catchment descriptor 643050_257850 is used to calculate the discharge rate from this pond.  FEH point rainfall 641430-261465 is used for this area.</p> <p><b>Risks:</b>  No topographical survey is available at the outfall location in the existing ditch.  Outfall data IL=17.30mAOD (assumed based on LIDAR).</p> <p><b>Next step:</b>  Topographical data of the proposed ditch at the outfall location is required.</p>

POND REFERENCE	CONTRIBUTING CATCHMENT AREA (HA)	MINIMUM ATTENUATION VOLUME (M <sup>3</sup> )	OUTFALL DETAILS				
			DISCHARGE RATE (L/S)	OWNER	CONSENTING BODY	CONFIDENCE	NOTES/ASSUMPTIONS/RISKS
PC-04-ATPN	6.65 (Converter station and its permanent access road)	5156.10	15.19	Private	East Suffolk WMB	High	<p><b>Notes:</b></p> <p>SSL carried out ground investigation at this location in December 2023. The Soakaway tests were undertaken in trial pits F22-TP136 and F22-TP316A in general accordance with recommended practice given in BRE Digest 365. Trial Pits have 2m deep. No groundwater encountered in the TPs at the pond location. Soakaway test at this location suggests extremely low permeability (No calculation of infiltration rate due to insufficient drop in water). Hence, discharge to nearest watercourse is proposed.</p> <p>FEH catchment descriptor 638850_261350 is used to calculate the discharge rate from this pond.</p> <p>FEH point rainfall 639361-262567 is used for this area.</p> <p>A new outfall in an Internal Drainage District must be consented by the Board under Byelaw 3.</p> <p>Outfall data IL=8.7mAOD (assumed based on LIDAR).</p> <p><b>Risks:</b></p> <p>Proposed 150mm diameter outlet to be 700m length at 1:80 gradient. The proposed IL is assumed based on 1m below LIDAR elevation.</p> <p><b>Next steps:</b></p> <p>A detailed topographical survey of the outfall is required to ensure the proposed IL.</p>

POND REFERENCE	CONTRIBUTING CATCHMENT AREA (HA)	MINIMUM ATTENUATION VOLUME (M <sup>3</sup> )	OUTFALL DETAILS				
			DISCHARGE RATE (L/S)	OWNER	CONSENTING BODY	CONFIDENCE	NOTES/ASSUMPTIONS/RISKS
PC-09-ATPN	0.43 (Permanent access road to Converter station)	512.90	2	Main River Consent with EA	EA	Lower	<p><b>Notes:</b> Discharge to nearest watercourse, either via gravity drainage pipe or a possible existing ditch leading to the river. Invert Level (IL) of the outfall is unknown. FEH catchment descriptor 638850_261350 is used to calculate the discharge rate from this pond. FEH point rainfall 639361-262567 is used for this area.</p> <p><b>Risks:</b> There is not topographical survey data of the proposed ditch affected by the new outfall.</p> <p><b>Next steps:</b> A detailed topographical survey of the outfall is required to ensure the proposed IL.</p>
PC-10-ATPN	0.28 (Permanent access road to Converter station)	299.80	2	Private	East Suffolk WMB	Lower	<p><b>Notes:</b> Discharge to nearest watercourse, either via gravity drainage pipe or a possible existing ditch leading to the river. Invert Level (IL) of the outfall is unknown. FEH catchment descriptor 638850_261350 is used to calculate the discharge rate from this pond. FEH point rainfall 639361-262567 is used for this area.</p> <p><b>Risks:</b> There is not topographical survey data of the proposed ditch affected by the new outfall.</p> <p><b>Next steps:</b> A detailed topographical survey of the outfall is required to ensure the proposed IL.  The proposed ditch is the receptor of two discharge rates( one for the PC -10-ATPN 2l/sec and TC-45ATPN of 2.35l/sec). The combined flow rate of 4.34l/sec is acceptable as one of the flow rates is temporary.</p>

# Appendix B Drainage Layouts

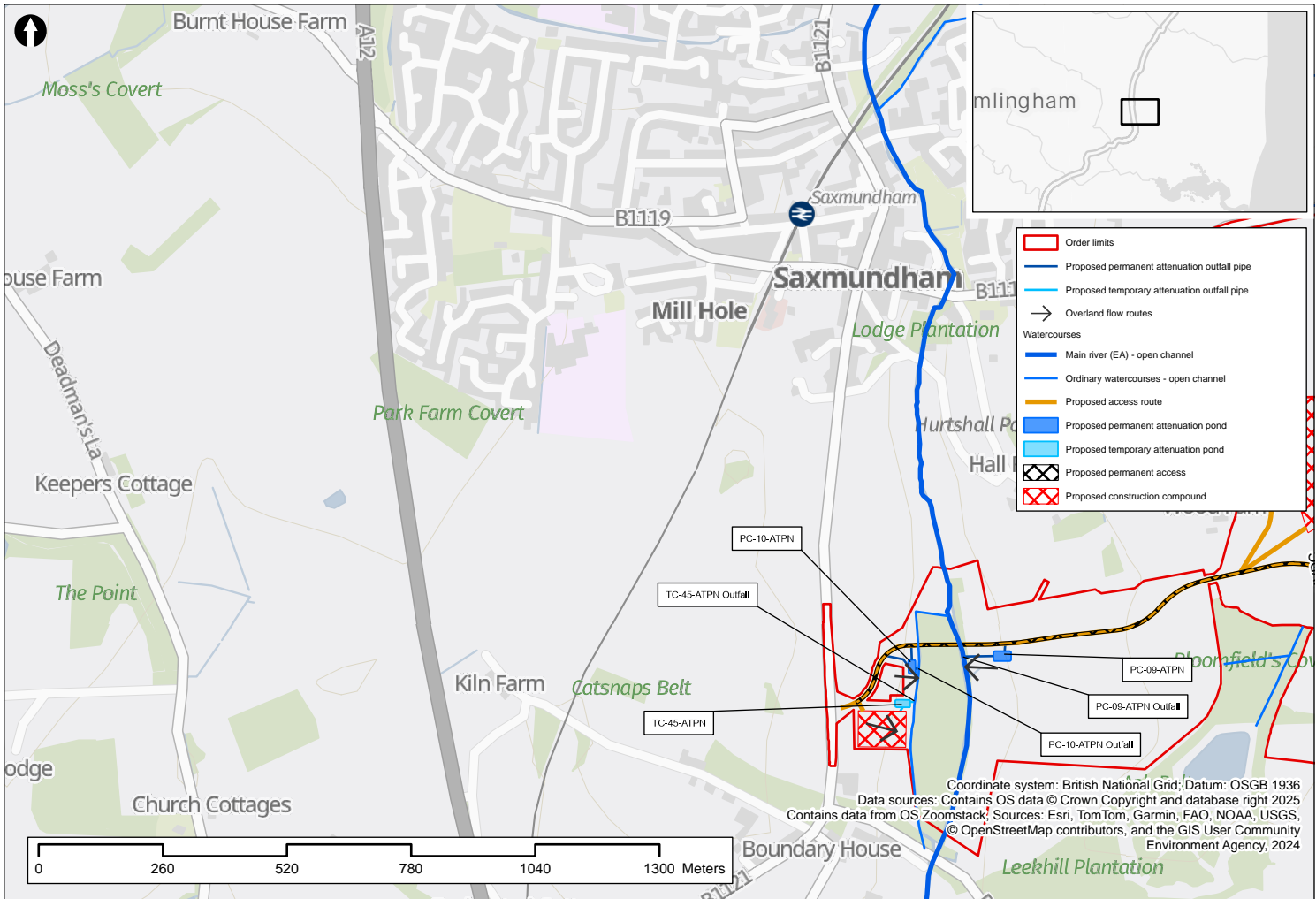

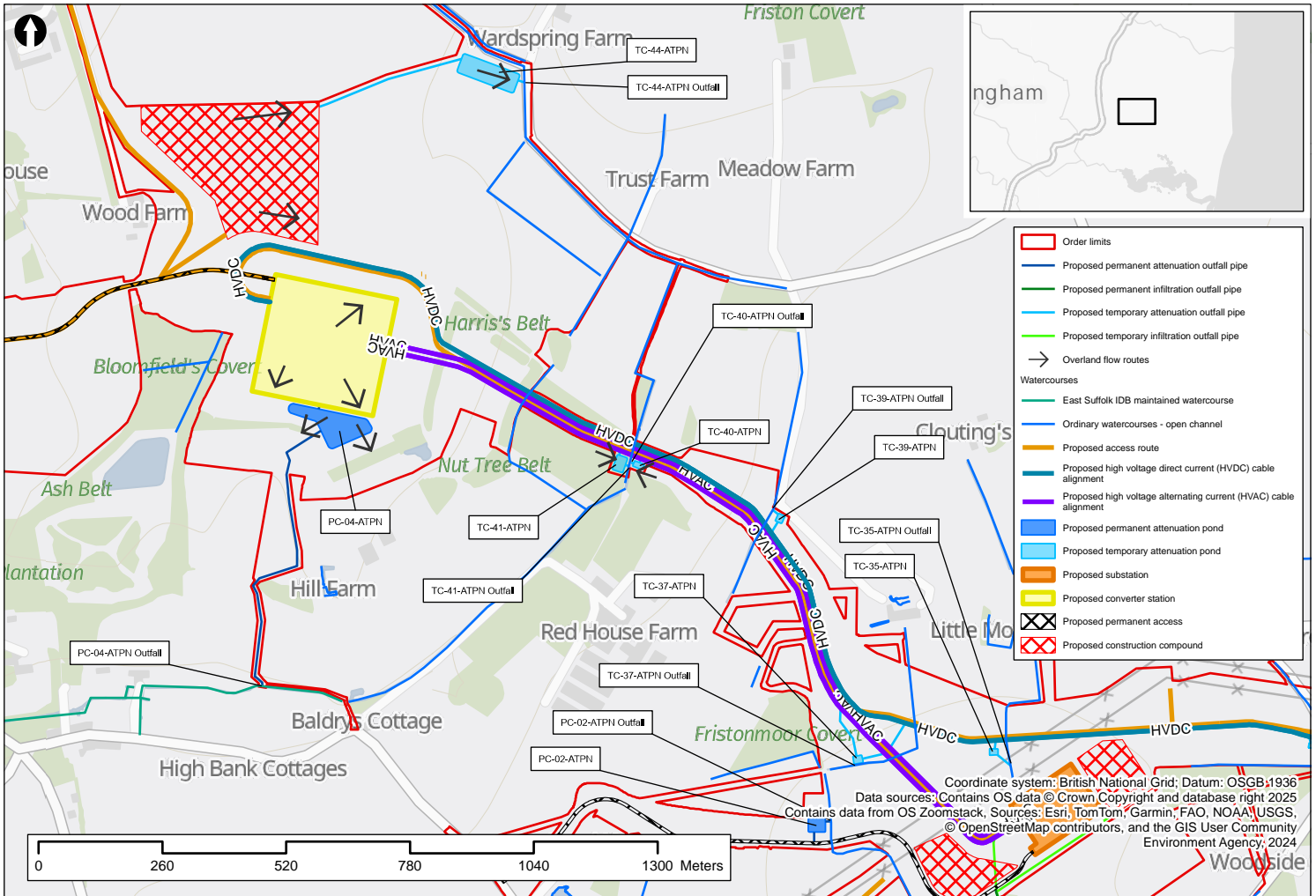

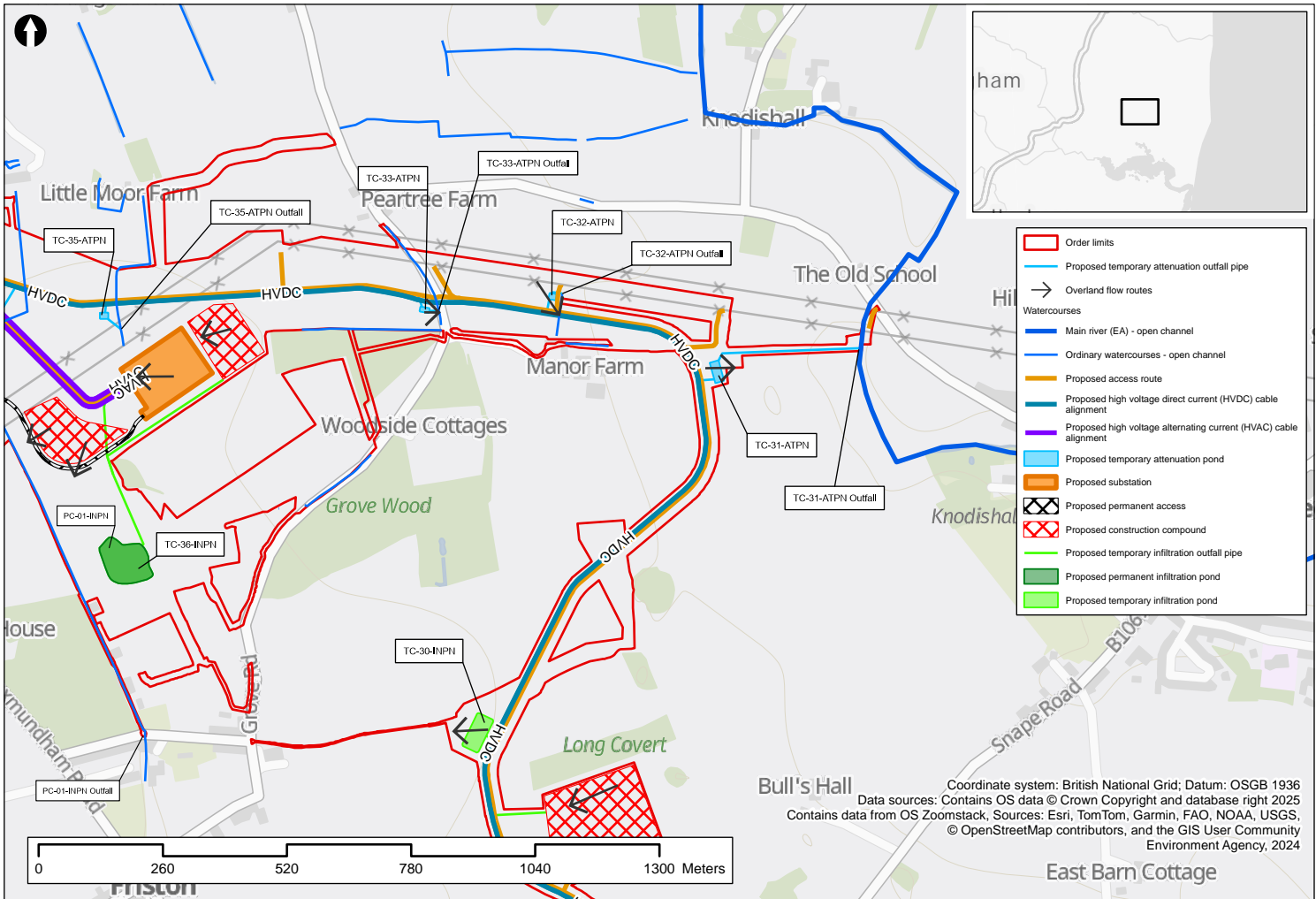

- Order limits
- Proposed temporary attenuation outfall pipe
- Overland flow routes
- Watercourses**
- Main river (EA) - open channel
- Ordinary watercourses - open channel
- Proposed access route
- Proposed high voltage direct current (HVDC) cable alignment
- Proposed high voltage alternating current (HVAC) cable alignment
- Proposed temporary attenuation pond
- Proposed substation
- Proposed permanent access
- Proposed construction compound
- Proposed temporary infiltration outfall pipe
- Proposed permanent infiltration pond
- Proposed temporary infiltration pond

Bull's Hall

Coordinate system: British National Grid; Datum: OSGB 1936  
 Data sources: Contains OS data © Crown Copyright and database right 2025  
 Contains data from OS Zoomstack, Sources: Esri, TomTom, Garmin, FAO, NOAA, USGS,  
 © OpenStreetMap contributors, and the GIS User Community  
 Environment Agency, 2024

East Barn Cottage



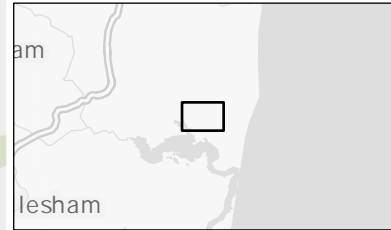
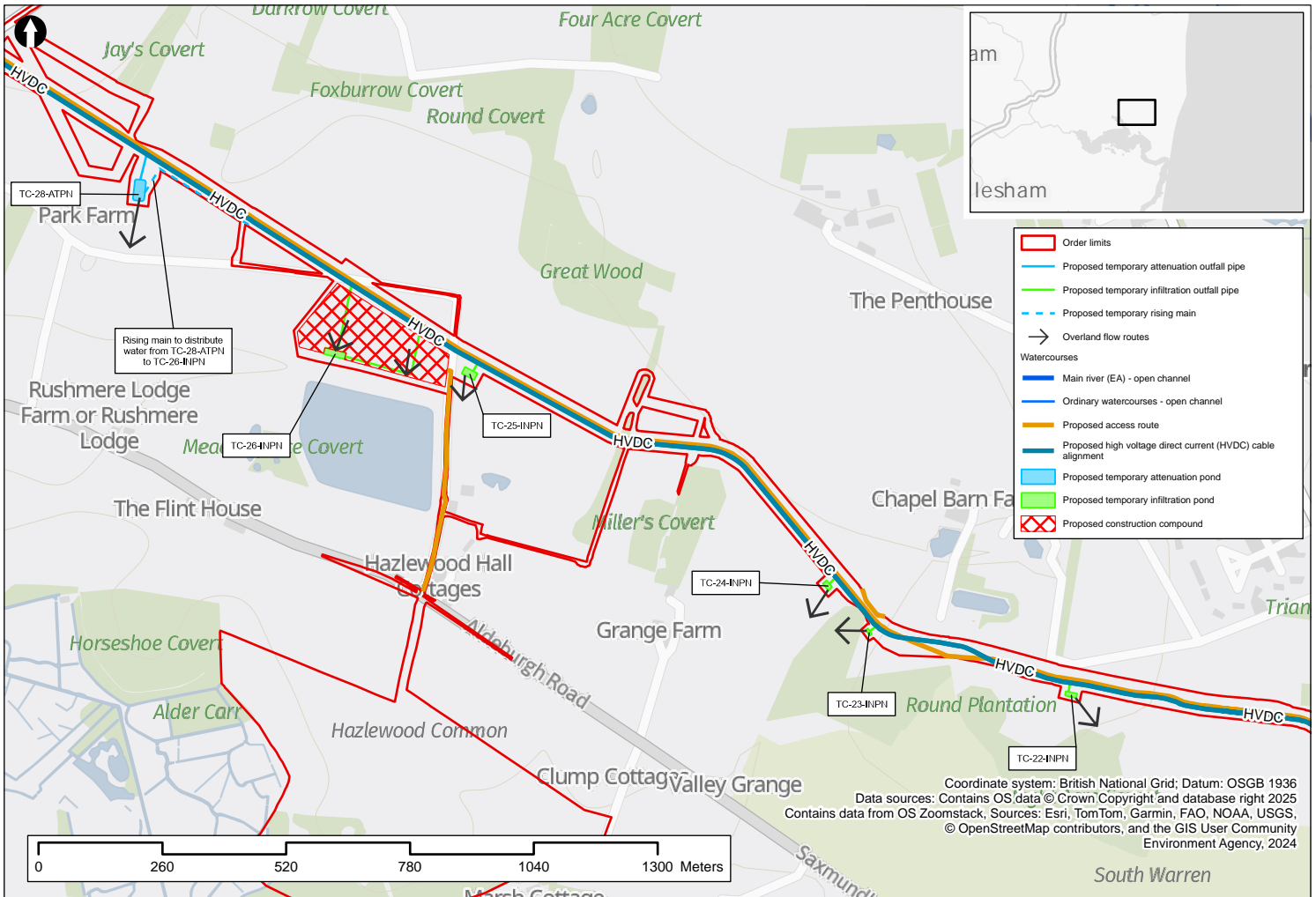

Rising main to distribute water from TC-28-ATPN to TC-26-INPN

Rushmere Lodge Farm or Rushmere Lodge

The Flint House

Hazlewood Hall Cottages

Grange Farm

Chapel Barn Farm

TC-22-INPN

TC-23-INPN

TC-24-INPN

TC-25-INPN

TC-26-INPN

TC-28-ATPN

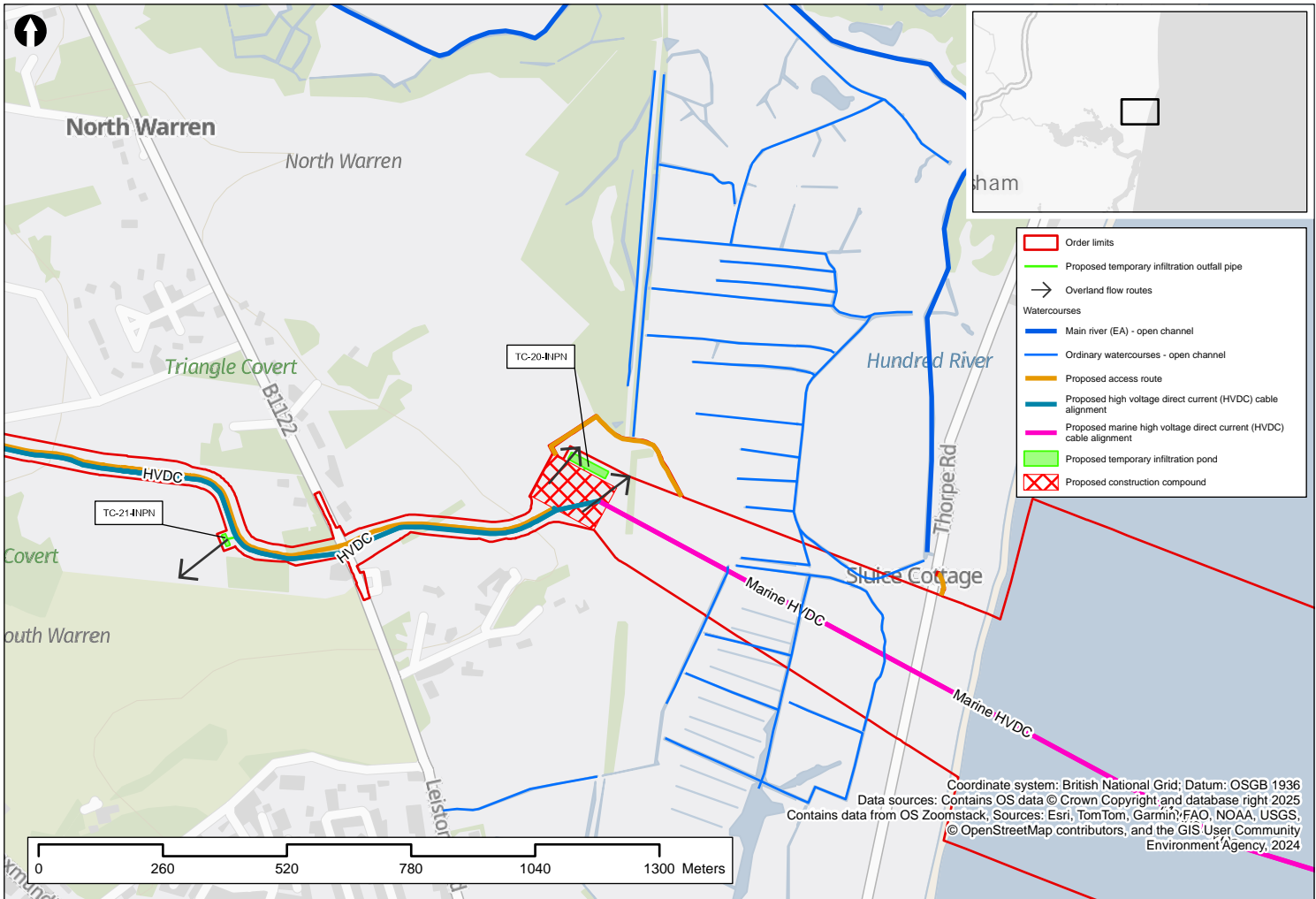

**Notes**

1. This plan is scaled at paper size A1, therefore any prints taken at smaller sizes will affect accuracy of the measurement units and should not be scaled against.
2. These plans will sit within the Order Limits. Due to the need for future flexibility, National Grid will be applying for Order Limits and Limits of Deviation within its Development Consent Order, within which any final alignment would lie. Therefore, all aspects of the authorised development, including the cable alignment, converter stations, substations and pylon locations should be treated as indicative only.
3. For further information on construction please refer to the construction section of the Environmental Statement.
4. For further information refer to the Drainage Strategies (Document Ref 9.17.1 and 9.17.2).
5. Legal easements and non planting zones will be included in further design development.
6. Reference should be made to the Guide to the Plans (Document Ref 2.1) which provides further information on what the plans show.

**TYPICAL DETENTION BASIN PLAN**

NTS

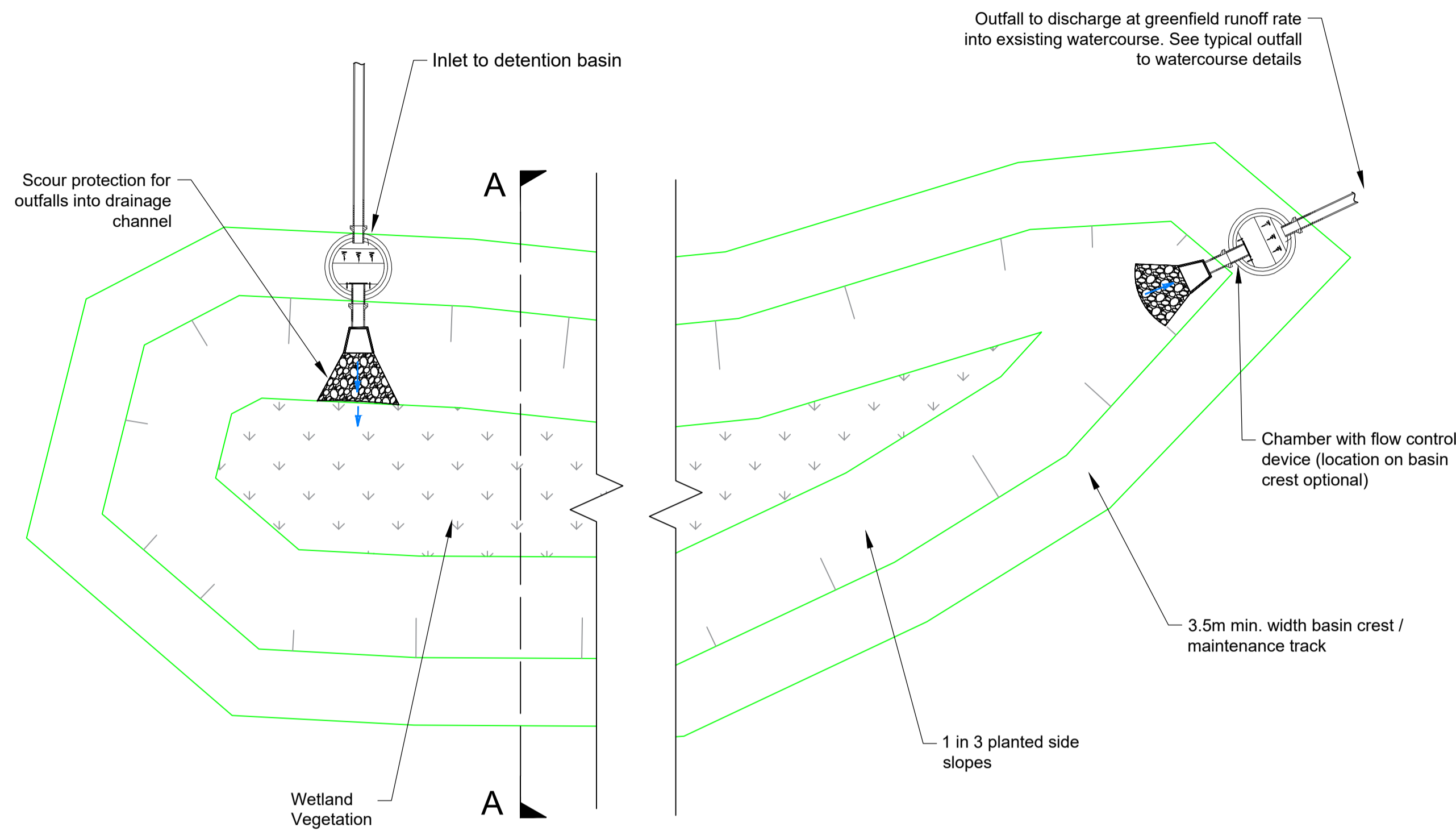

**SECTION OF OUTLET HEADWALL FROM DETENTION BASIN**

Scale 1:20

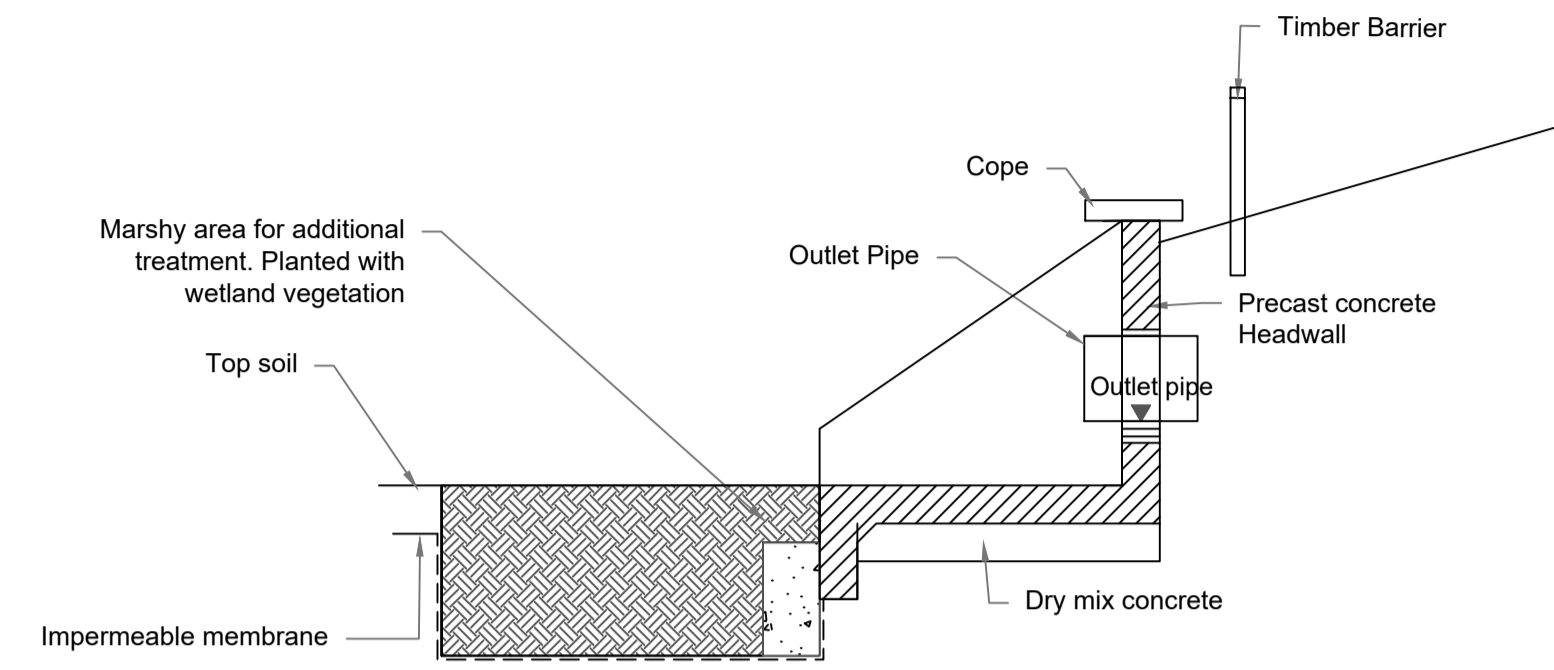

**SECTION OF INLET HEADWALL INTO DETENTION BASIN**

Scale 1:20

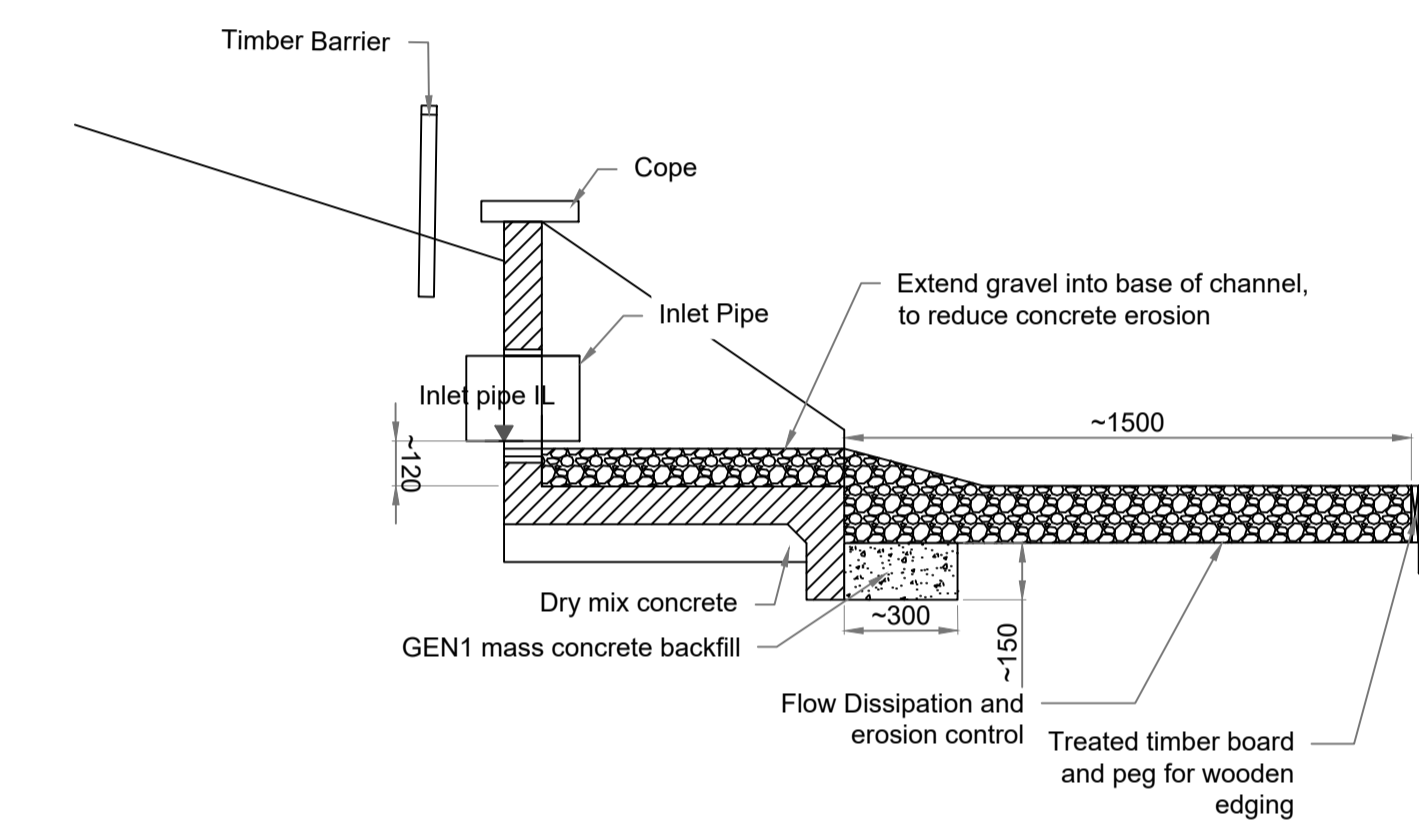

**TYPICAL DETENTION BASIN SECTION (SECTION A-A)**

NTS

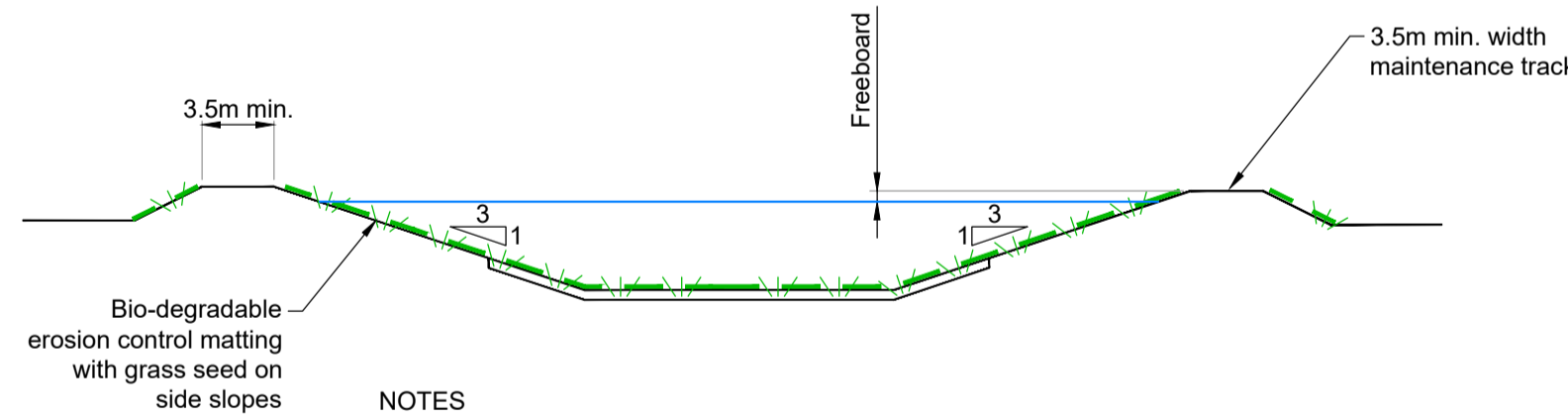

**NOTES**

1. Side slopes and dimensions as noted in Drainage Strategy (Ref. 9.17.1 and 9.17.2).
2. Bio-degradable erosion control matting to be installed where required.
3. Profile of basin to have natural rounded transition between base, side slopes and adjacent ground.

**TYPICAL DETENTION BASIN LONG SECTION**

NTS

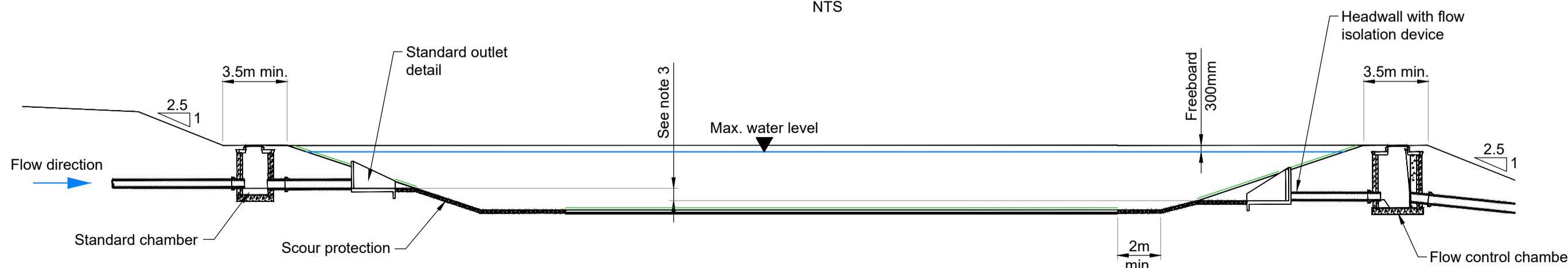

**NOTES**

1. Side slopes and dimensions as noted in Drainage Strategy (Ref. 9.17.1 and 9.17.2).
2. Profile of basin to have natural rounded transition between base, side slopes and adjacent ground.
3. Difference between inlet and outlet levels should be sufficient to ensure that basin drains as intended (typically 0.5% along flow path).

**TYPICAL DETAIL OF OUTFALL TO ROAD DITCH**

Scale 1:20

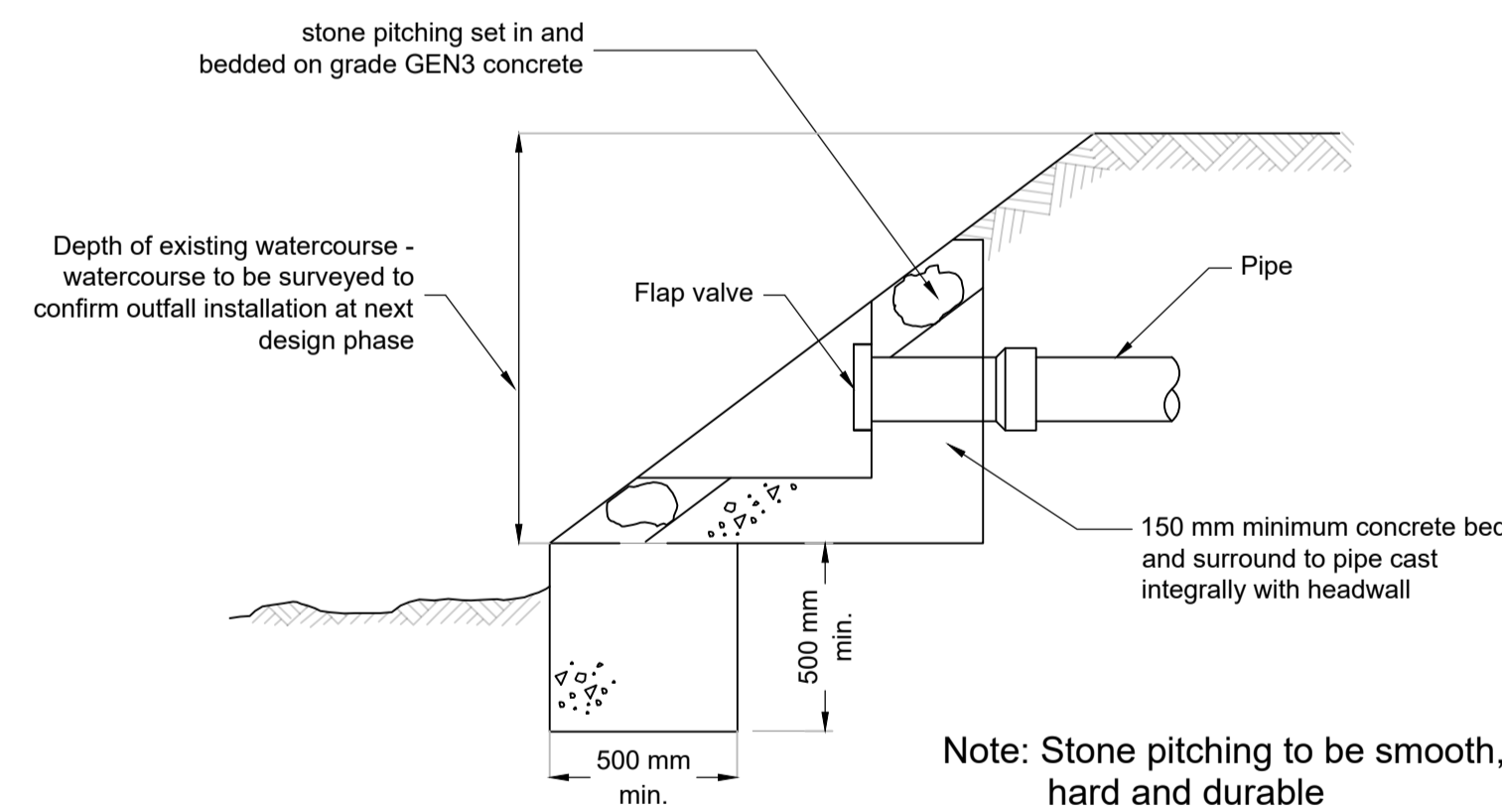

Note: Stone pitching to be smooth, hard and durable

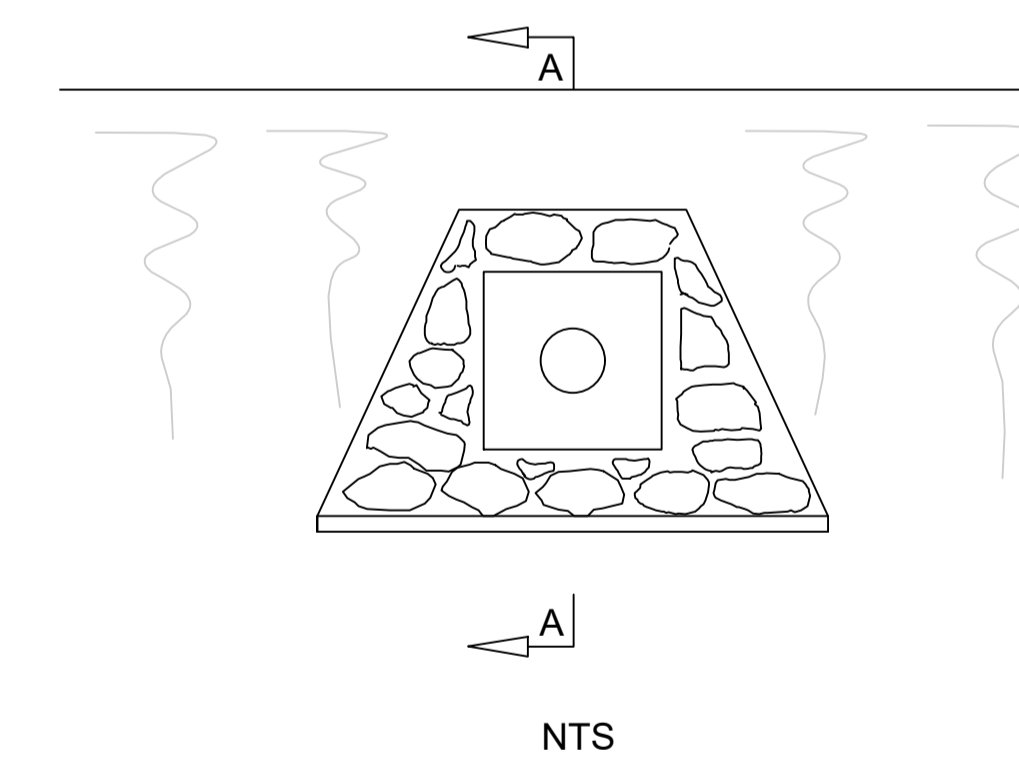

**FRONT ELEVATION**

**SECTION A-A**

**TYPICAL DRAINAGE SWALE SECTION DETAIL**

Scale 1:20

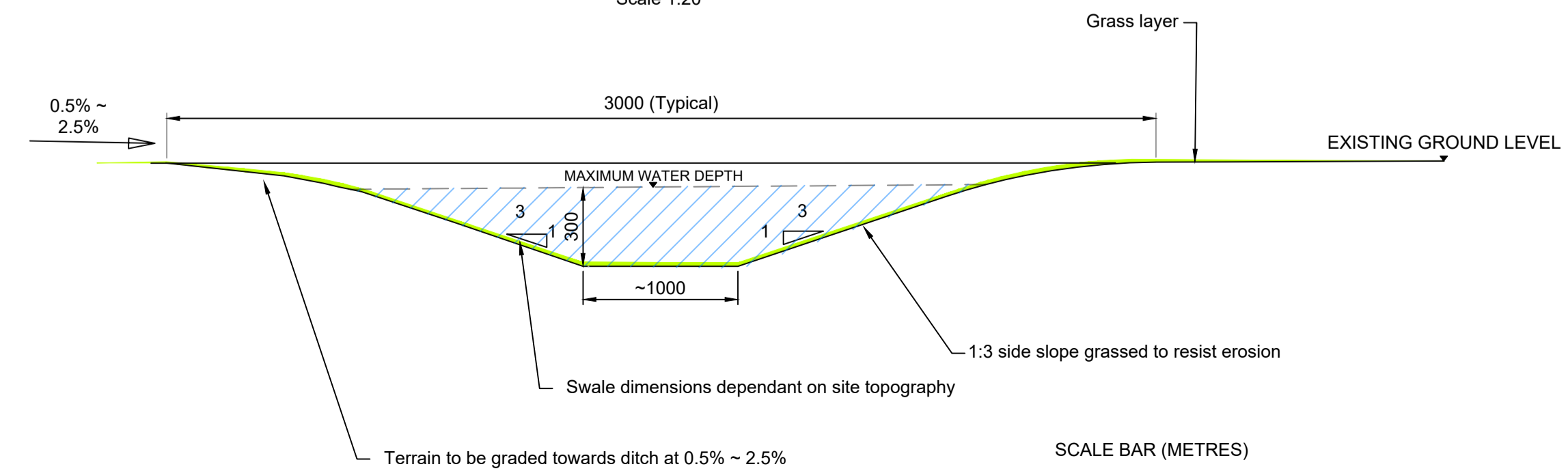

**SCALE BAR (METRES)**

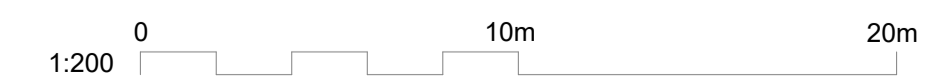

**Legend**

Illustrative as shown

**Abbreviations:**

- FFL - Finished Floor Level
- C.L. - Cover Level
- NTS - Not To Scale

Sheet X Centroid Coordinate: Sheet Y Centroid Coordinate:

Issue	Date	Remarks	Drawn	Checked	Approved
A	23/02/2026	For Submission	AW	LS	JW

**THE NATIONAL GRID (SEA LINK) ORDER  
 PINS APPLICATION NUMBER: EN020026  
 TYPICAL DRAINAGE DETAILS  
 SHEET 1 OF 1**

**nationalgrid**

Application Number: EN020026

National Grid Drawing Reference: SEAL-MMD-SEAL-ENG-DWG-0817

Scale	Sheet Size	Sheet	Issue
AS SHOWN	A1	SHEET 1 OF 1	A

# Appendix C Additional Insets

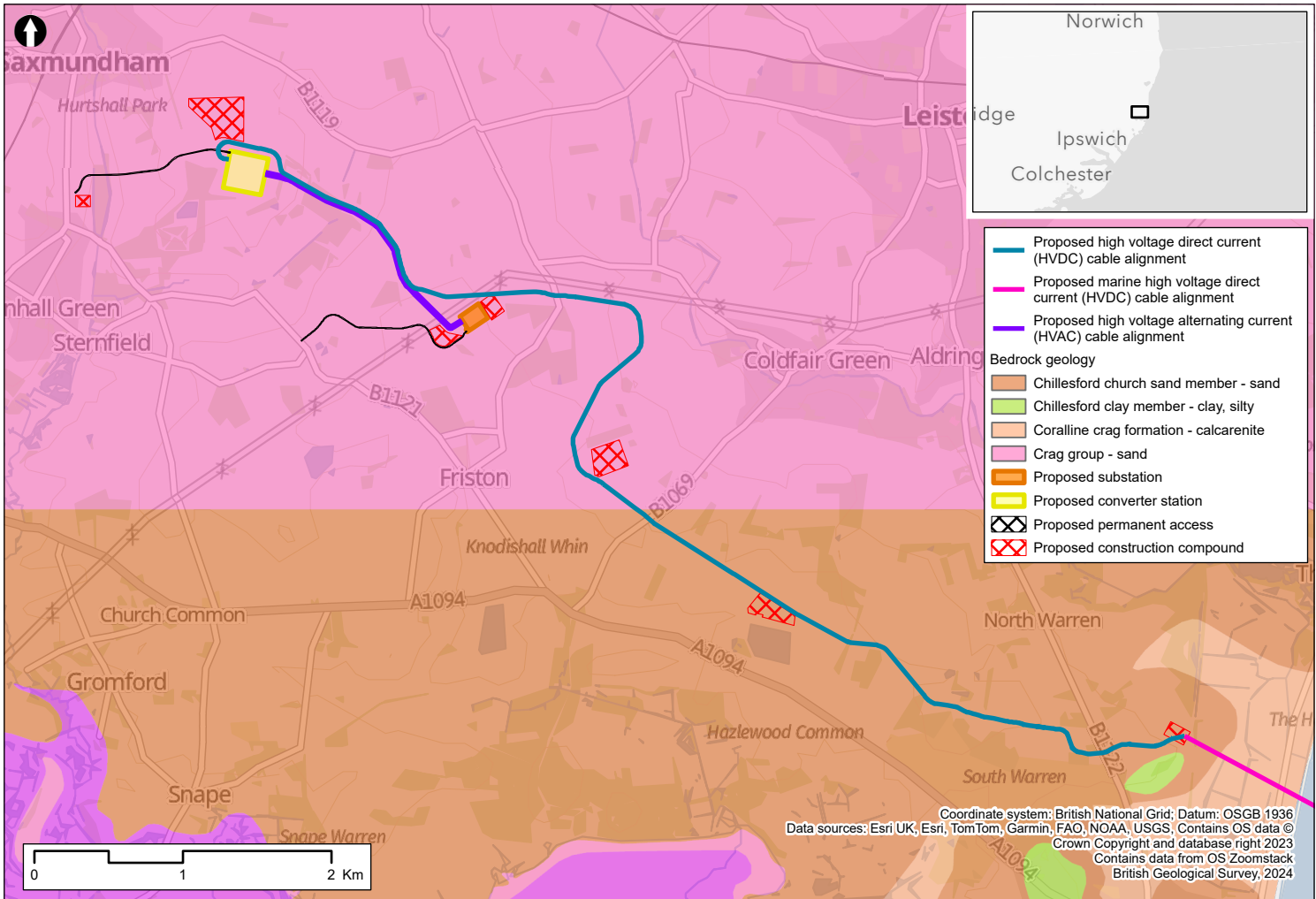

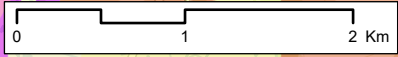
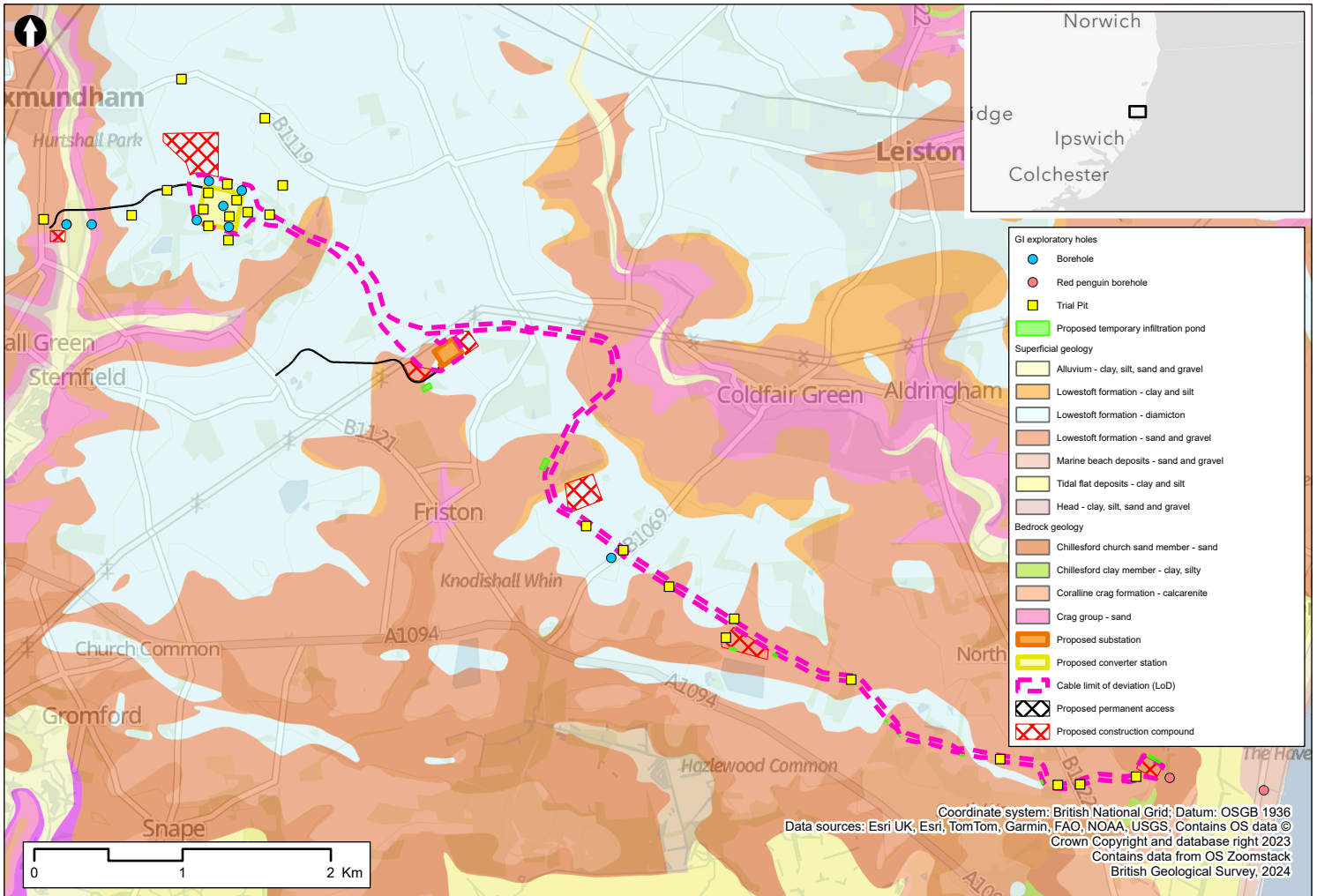

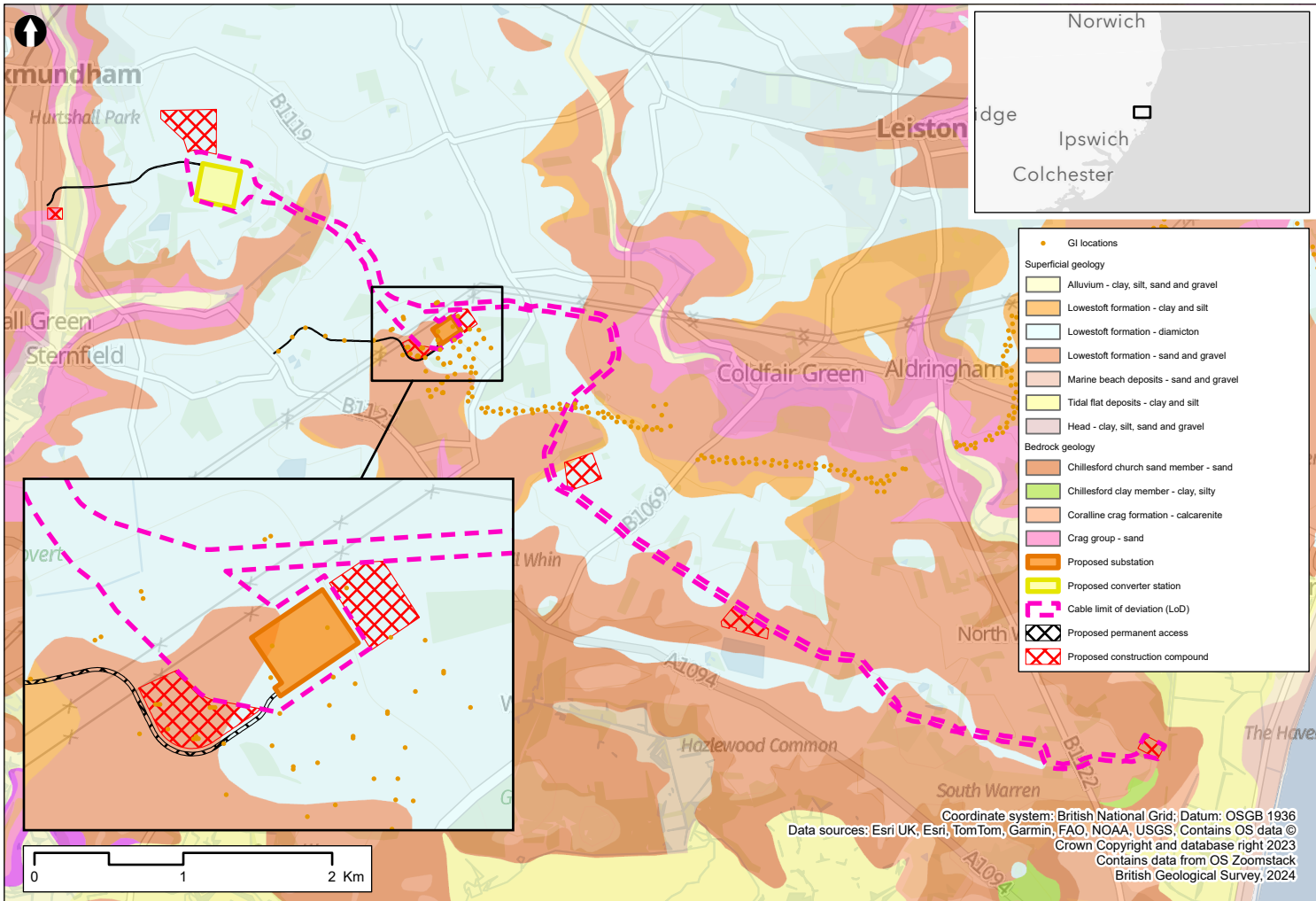

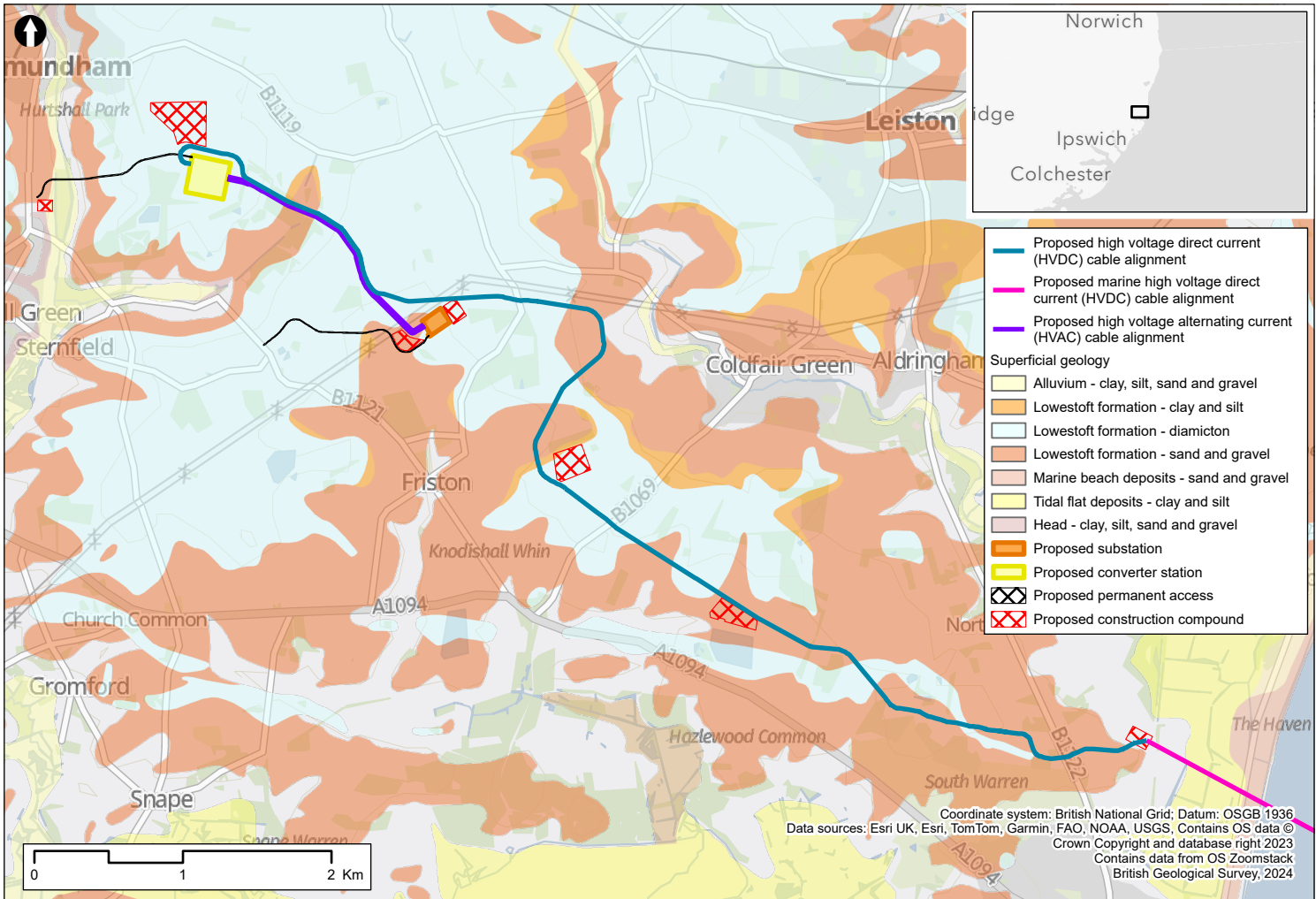

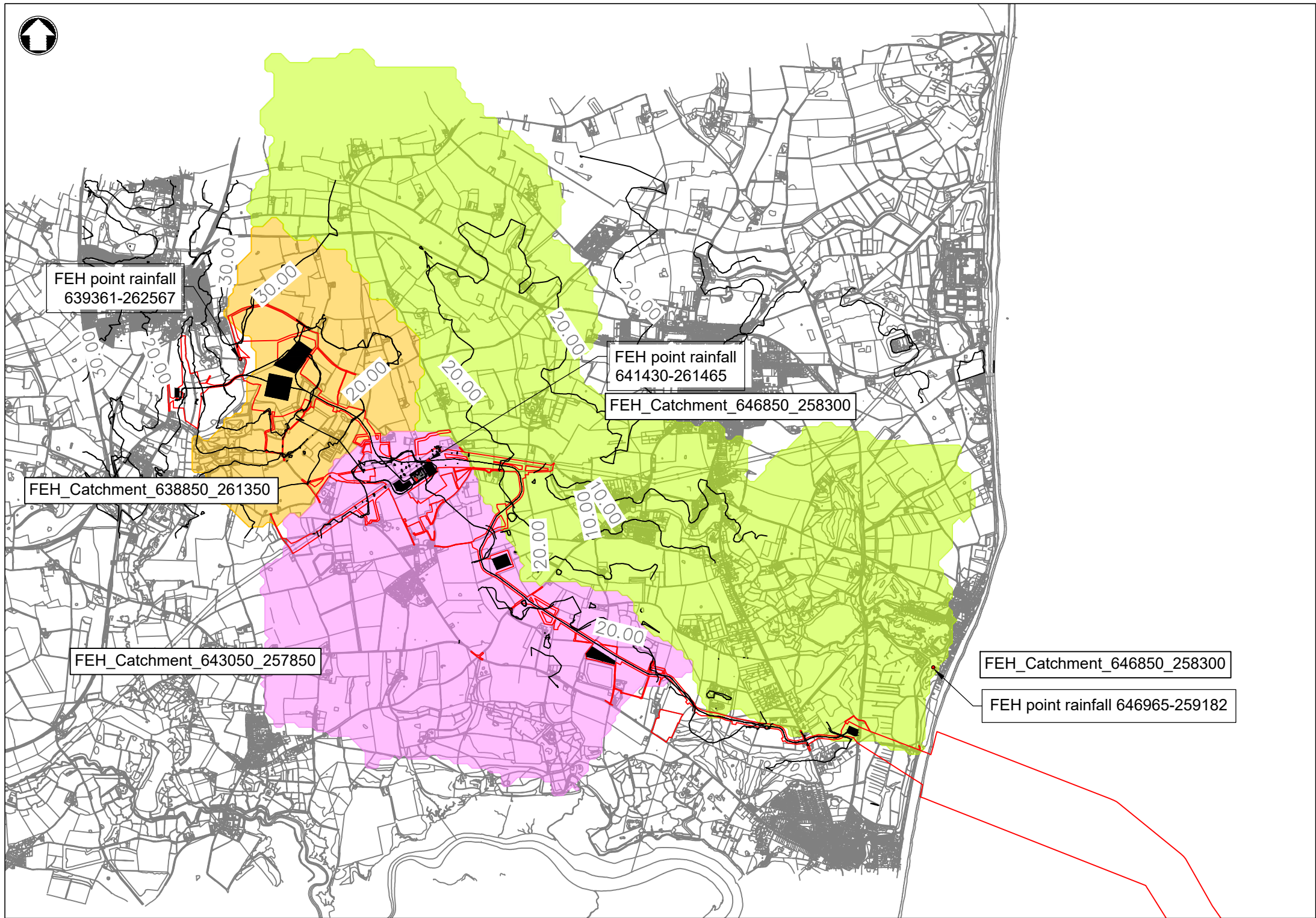

# Appendix D Consultation Responses

This appendix covers a summary of those statutory consultation responses that have been received from 2022 to 2024, as a response of the initial engagement during August 2022 with the different consultees. Note that there may be updates to this information during examination, which will be recorded in the Statements of Common Ground for the appropriate stakeholder.

- August 2022 / Sea Link – Suffolk Interface with Environment Agency (Suffolk) regarding crossing of rivers. SEAL-MMD-SEAL-ENG-TCN-0213.
- August 2022 / Sea Link – Suffolk Interface with Suffolk County Council regarding crossing of rivers. SEAL-MMD-SEAL-ENG-TCN-0215.
- August 2022 / Sea Link – Suffolk Interface with East Suffolk IDB regarding crossing of rivers. SEAL-MMD-SEAL-ENG-TCN-0214.

A summary of the responses from stakeholders and regard with the Drainage Strategy design have been captured in Table D1.

Details of the minutes from the drainage stakeholder engagement meetings with the relevant water authorities are recorded in the documents:

- Memorandum of Understanding Environment Agency (Suffolk) SEAL-MMD-SEAL-ENG-REP-0477 dated November 2022.
- Memorandum of Understanding Suffolk County Council SEAL-MMD-SEAL-ENG-REP-0482 dated November 2022.
- Memorandum of Understanding East Suffolk IDB SEAL-MMD-SEAL-ENG-REP-0478 dated November 2022.
- Memorandum of Understanding River Stour IDB SEAL-MMD-SEAL-ENG-REP-0480 dated January 2025
- Memorandum of Understanding North Warren Nature Reserve SEAL-MMD-SEAL-ENG-REP-0481.
- Mott MacDonald River Crossing Consultation by the Environment Agency Suffolk.

A Section 42 consultation for the proposed Sea Link project was conducted during 2023-2024. The summary of the comments and actions which were specific to the Sea Link project are included in Table D1.

**Table D.1 Consultation responses in relation with the drainage strategy report**

<b>Consultee</b>	<b>Date/ Document</b>	<b>Comment</b>	<b>Response / where addressed in the Drainage Strategy report</b>
EA Suffolk	<p><b>August 2022 /</b> Sea Link – Suffolk Interface with Environment Agency regarding crossing of rivers. EAL- MMD-SEAL- ENG-TCN- 0213.</p> <p><b>October 2022 /</b> River Crossing Consultation with EA. AC/2022/13133 6/01-L01.</p> <p><b>November 2022 /</b> Memorandum of Understanding - Environment Agency (Suffolk) / SEAL-MMD- SEAL-ENG- REP-0477.</p>	<p>HDD crossing beneath watercourse requires 2m minimum depth, but it depends on substrate conditions.</p> <p>Anti-culverting policy on Main Rivers, clear-span bridge crossing required.</p> <p>HDD is the crossing methodology of Thorpeness Hundred, the applicant is likely to be able to register for a permit exemption (FRA3) and a FRAP is unlikely to be required.</p> <p>A form of permission will be required for the construction of any new outfalls into a main River (Hundred River and Fromus River).</p> <p>Flood Risk Activity Permits will be required for:</p> <p>Any activities in, over or under a main river.</p> <p>Activities in the 8m of a non-tidal main river or 16m of a non-tidal main river.</p> <p>Activities in the floodplain greater than 8m (16m for tidal) from a main river or flood defence structure</p>	<p>Hundred River is not crossed by the cable route. Fromus River is crossed by a bridge.</p> <p>A new permanent outfall is proposed into Fromus River. All Consents are indicated in Section 8.2.</p>
Lead Local Flood Authority (Suffolk County Council)	<p><b>August 2022 /</b> Sea Link – Suffolk Interface with Suffolk County Council regarding crossing of rivers.</p>	<p>All Watercourses that do not sit within IDB catchments or are EA maintained are regulated for consent by SCC.</p> <p>Discharge rates to be agreed with LLFA and IDB as part of the planning application. Discharge may need Land Drainage</p>	<p>Appendix A of this report show the discharge rate of all new permanent and temporary outfalls into the existing watercourses. Section 4.2 identified the ownership of every watercourse affected by the Sea Link project.</p>

<b>Consultee</b>	<b>Date/ Document</b>	<b>Comment</b>	<b>Response / where addressed in the Drainage Strategy report</b>
	EAL-MMD-SEAL-ENG-TCN-0215.  <b>November 2022 /</b> Memorandum of Understanding Suffolk County Council / SEAL-MMD-SEAL-ENG-REP-0482.	Consent due to construction of headwalls. Reinstatement to be like for like, with original levels reestablished. Design Criteria for proposed temporary works: 1 in 30 years plus 20% Climate Change Proposed. Design Criteria for proposed permanent works: 1 in 100 years plus 45% Climate Change Agreed.	LLFAs will not accept 5l/s minimum discharge rate, it requires Qbar for all events. 2 l/s standard minimum discharge rate.
	March 2023	The Suffolk SuDS Guide updated (March 2023). FEH Methodology used to obtain Greenfield Runoff Rates (Qbar).	Temporary SuDS designed and built for the construction phase only must be designed to manage runoff for all events up to and including the 1in100 (1%) AEP storm (SCC local standard). The FEH catchment descriptors have been used to obtain the greenfield runoff rates in accordance with SCC Local SuDS Guidance dated March 2023
East Suffolk IDB	<b>November 2022 /</b> Memorandum of Understanding East Suffolk IDB SEAL-MMD-SEAL-ENG-REP-0478.	Bylaw 10 – Any intervention within 9m radius from maintained IDB watercourse requires consent. Any other watercourse within IDB catchment districts, excluding main rivers, are regulated by East Suffolk IDB. No consent required for HDD crossing underneath non-Board maintained watercourses within IDB catchment. Consent will still be needed from land/riparian owner. Design Criteria for proposed permanent works: 1 in 100 years	Design criteria for permanent and temporary surface water structures as per SCC guidance. Section 4.2 identified the ownership of every IDB watercourse affected by the Sea Link project. No outfalls are proposed on the NWNR.

Consultee	Date/ Document	Comment	Response / where addressed in the Drainage Strategy report
		<p>plus 40% Climate Change Agreed.</p> <p>Design Criteria for proposed temporary works: 1 in 5 years plus 10% Climate Change Agreed. Dependent on duration of the works.</p> <p>Cable depth below hard bed at the crossing - 2m.</p> <p>New outfalls into the North Warren Nature Reserve (NWRN) require consent by the IDB but NWRN must also give permission.</p>	

# Appendix E Soakaway Tests

This section shows an extract of the soakaway tests used in this report.

The two reports listed below are taken as a reference for these results:

- Onshore Geotechnical and Geo-Environmental Ground Investigation Report (Structural Soils Ltd, 2022, EA1N-GRD-GEO-REP-SSL-000001 REV 21)
- Factual Report on Preliminary Ground Investigation (Structural Soils Ltd, 2024, Report No.: 563835-01 (03)).

# FULL SCALE SOAKAWAY TEST

In accordance with BRE Digest 365

Soakaway Test - Position ID : TP017B

Ground Level (m AOD): **14.03**

National Grid Co-ordinates: **E:641284.5 N:260873.4**

## Plot of Depth of Water Below Ground Level Against Time

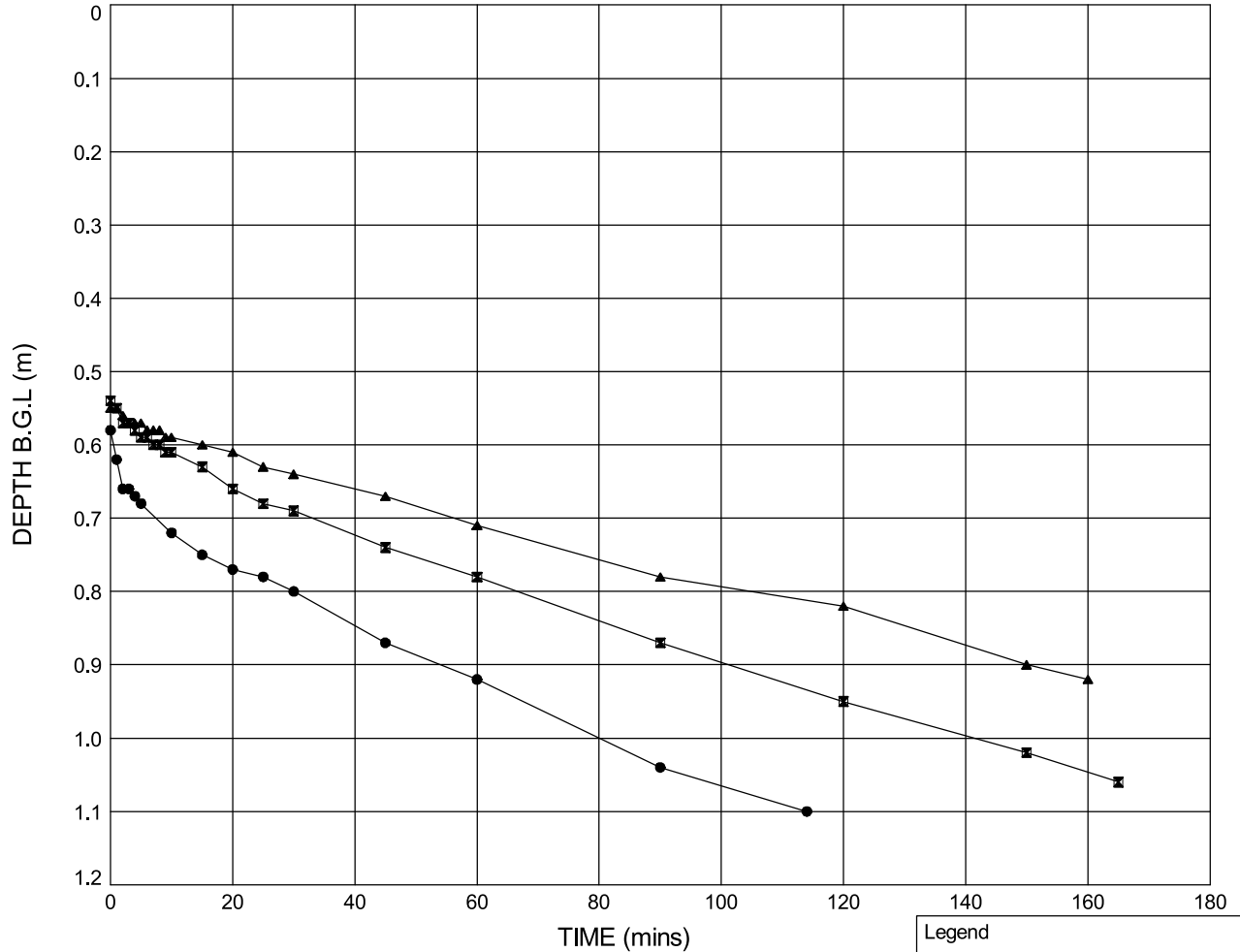

	Test 1	Test 2	Test 3	
Pit start depth:	= 1.20	1.20	1.20	m
Pit final depth:	= 1.20	1.20	1.20	m
Effective depth, $D_e$	= 0.62	0.66	0.65	m
Effective storage volume, $V_{p75-25}$	= 0.2480	0.2640	0.2600	$m^3$
Surface area, $a_{p50}$	= 1.9160	1.9880	1.9700	$m^2$
Time, $t_{p75-25}$	= 4770	7267	9461	secs
Infiltration rate, $f$	= $2.71 \times 10^{-5}$	$1.83 \times 10^{-5}$	$1.39 \times 10^{-5}$	m/s

Please note test data was extrapolated to obtain  $t_{p75-tp25}$ .

Legend		
●	Test 1	(25.05.21)
■	Test 2	(25.05.21)
▲	Test 3	(25.05.21)

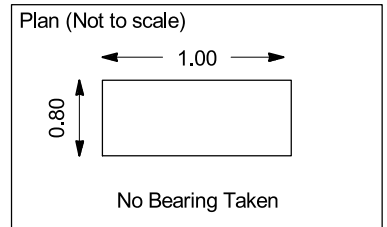

GINT\_LIBRARY\_V10\_01.GLB LibVersion: v8\_07\_001 PjVersion: v8\_07 | Graph 1 - TP SOAKAWAY - 2 - FINAL REPORT - A4P | 735329-EA-HUB-ONSHORE-1.GPJ - v10\_01 | 25/08/21 - 15:01 | KL2 |



**STRUCTURAL SOILS**  
The Old School  
Stillhouse Lane  
Bedminster  
Bristol BS3 4EB

Compiled By	Date	Checked By	Date
[Redacted]	25/08/21		
Contract		Contract Ref:	
Onshore Geotechnical and Geo-Environmental Ground Investigation		735329	

# FULL SCALE SOAKAWAY TEST

In accordance with BRE Digest 365

Soakaway Test - Position ID : **F22-TP404A**

Test Supervisor : **MCapitani**

Ground Level (m AOD): **13.06**

National Grid Co-ordinates: **E:643184.7 N:259363.9**

## Plot of Depth of Water Below Ground Level Against Time

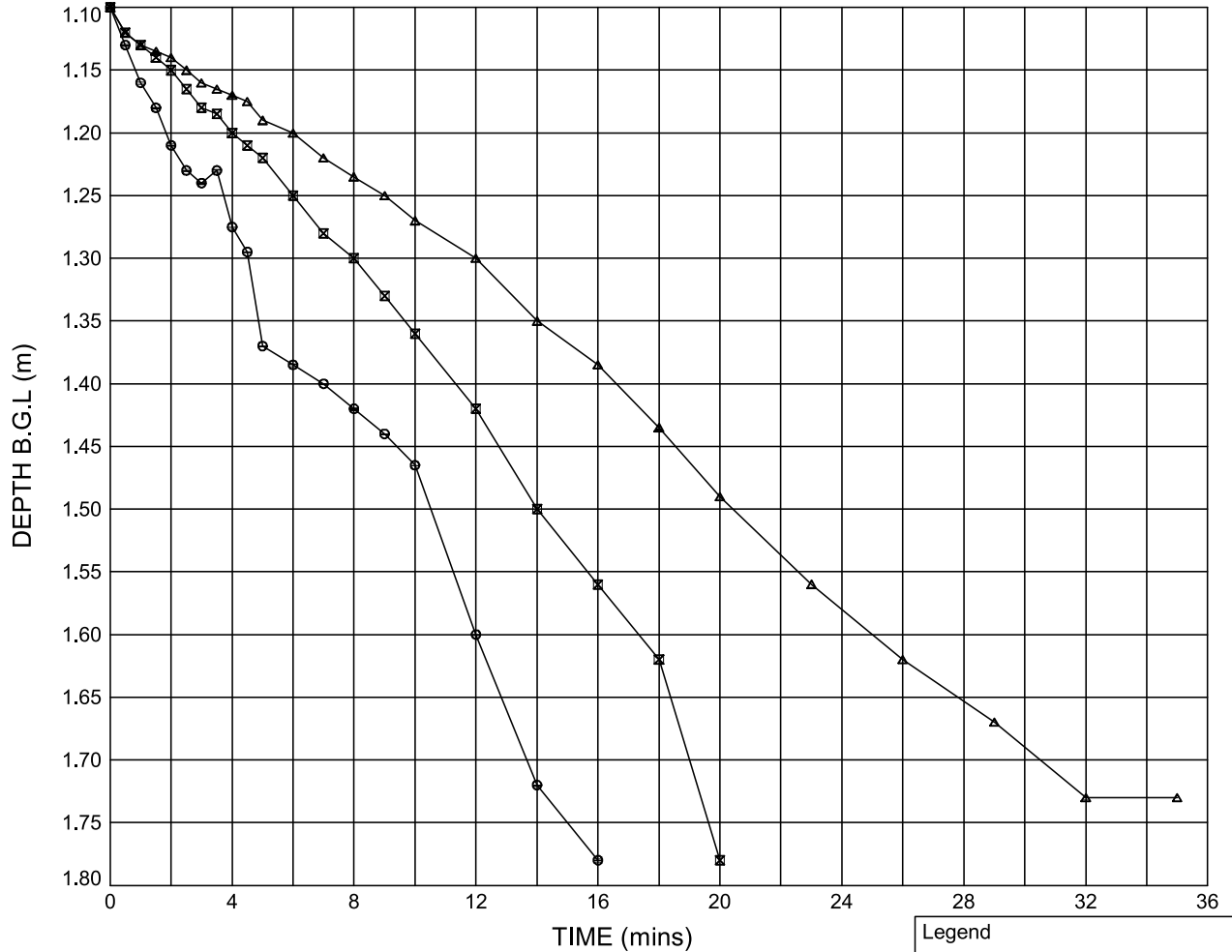

	Test 1	Test 2	Test 3	
Pit start depth:	= 1.80	1.80	1.80	m
Pit final depth:	= 1.70	1.66	1.65	m
Effective depth, $D_e$	= 0.70	0.70	0.70	m
Fill Porosity	= 23	23	23	%
Effective storage volume, $V_{p75-25}$	= 0.1449	0.1449	0.1449	$m^3$
Surface area, $a_{s50}$	= 4.3200	4.3200	4.3200	$m^2$
Time, $t_{p75-25}$	= 505.0	674.0	958.0	secs
Infiltration rate, $f$	= $6.64 \times 10^{-5}$	$4.98 \times 10^{-5}$	$3.50 \times 10^{-5}$	m/s

Notes: Test 1 - Pit supported using clean 35mm diameter granular fill.

Legend		
⊖	Test 1	(04.10.23)
⊠	Test 2	(04.10.23)
▲	Test 3	(04.10.23)

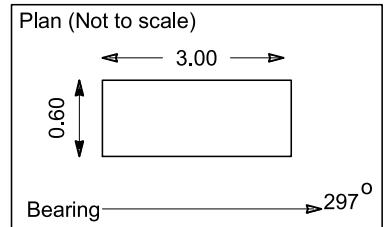

GINT\_LIBRARY\_V10\_01\_GLB LibVersion: v8\_07\_001 ProjVersion: v8\_07 | Graph 1 - TP SOAKAWAY - 2 - FINAL REPORT - A4P | 563835\_SEALINK\_FRISTON.GPJ - v10\_01 | 07/03/24 - 14:19 | AML11

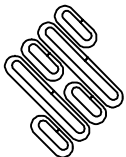

**STRUCTURAL SOILS**  
18 Frogmore Road  
Hemel Hempstead  
Hertfordshire  
HP3 9RT

Compiled By	Date	Checked By	Date
[Redacted]	[Redacted]	[Redacted]	07/03/24
Contract		Contract Ref.	
Sealink Friston		563835	

# FULL SCALE SOAKAWAY TEST

In accordance with BRE Digest 365

Soakaway Test - Position ID : F22-TP513A

Test Supervisor : H Tribick

Ground Level (m AOD): 17.37

National Grid Co-ordinates: E:645573.9 N:258373.8

## Plot of Depth of Water Below Ground Level Against Time

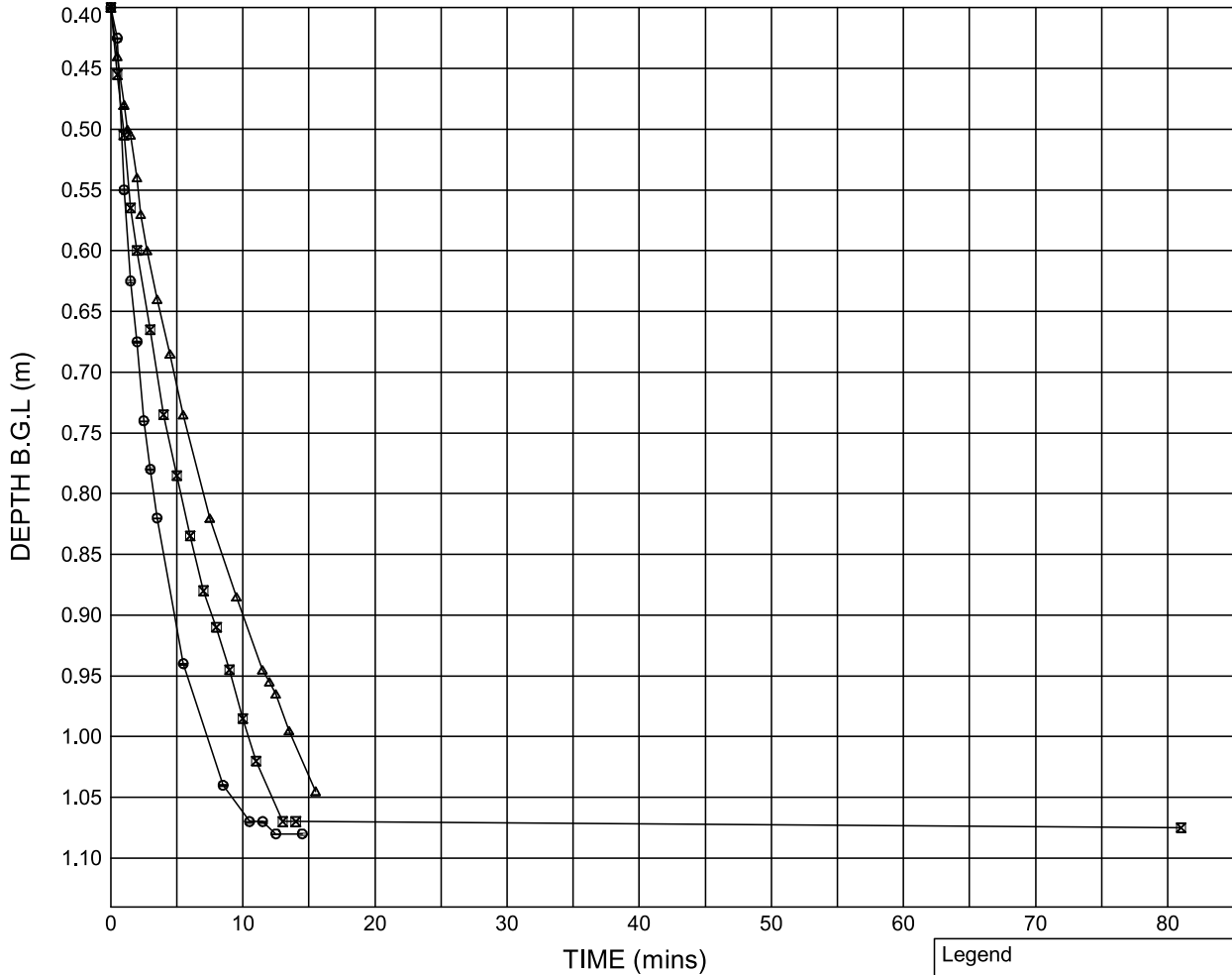

	Test 1	Test 2	Test 3	
Pit start depth:	= 1.14	1.14	1.14	m
Pit final depth:	= 1.10	1.10	1.10	m
Effective depth, $D_e$	= 0.74	0.74	0.74	m
Fill Porosity	= 23	23	23	%
Effective storage volume, $V_{p75-25}$	= 1.0640	1.0640	1.0640	$m^3$
Surface area, $a_{s50}$	= 3.4700	3.4700	3.4700	$m^2$
Time, $t_{p75-25}$	= 283.0	448.0	570.0	secs
Infiltration rate, $f$	= $1.08 \times 10^{-4}$	$6.84 \times 10^{-5}$	$5.38 \times 10^{-5}$	m/s

Notes: Test 1 - Test completed with granular fill used to support pit.

Legend		
⊖	Test 1	(04.10.23)
⊠	Test 2	(04.10.23)
▲	Test 3	(04.10.23)

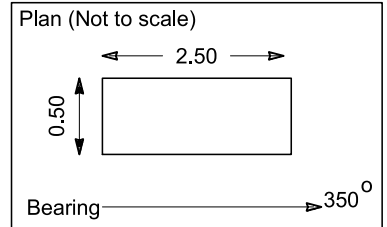

GINT\_LIBRARY\_V10\_01.GLB LibVersion: v8\_07\_001 ProjVersion: v8\_07 | Graph 1 - TP SOAKAWAY - 2 - FINAL REPORT - A4P | 563835\_SEALINK\_FRISTON.GPJ - v10\_01 | 07/03/24 - 14:23 | AML1 |

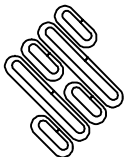

**STRUCTURAL SOILS**  
18 Frogmore Road  
Hemel Hempstead  
Hertfordshire  
HP3 9RT

Compiled By	Date	Checked By	Date
[Redacted]	[Redacted]	[Redacted]	07/03/24
Contract		Contract Ref.	
Sealink Friston		563835	

National Grid plc  
National Grid House,  
Warwick Technology Park,  
Gallows Hill, Warwick.  
CV34 6DA United Kingdom

Registered in England and Wales  
No. 4031152  
[nationalgrid.com](http://nationalgrid.com)